

LM192 LIGHT METER

INSTRUCTION MANUAL



ALWAYS READ THESE INSTRUCTIONS BEFORE PROCEEDING

Thank you for buying one of our products. For safety and a full understanding of its benefits please read this manual before use. Technical support is available from 01923 441717 and support@martindale-electric.co.uk.

CONTENTS

1	Safety Information	1
1.1	Meaning of Symbols and Markings	1
1.2	Precautions	2
2	Introduction	3
2.1	Inspection	3
2.2	Description	3
2.3	Accessories	3
2.4	Battery Installation	3
3	Operation	4
3.1	Description of Press Buttons and LM195 Elements	4
3.2	Description of LCD Symbols	5
3.3	Low Battery Indication	5
3.4	Power On/Off	6
3.5	Auto Power Off	6
3.6	Backlight	7
3.7	Min Max	7
3.8	Hold Mode	7
3.9	Unit of Measurement	7
3.10	Auto/Manual Ranging	8
3.11	Measurement Mode	8
3.12	Measurement Considerations	8
3.13	CIE Photopic Curve	10
4	Maintenance	12
4.1	Battery Replacement	12
4.2	Calibration	12
4.3	Cleaning	13
4.4	Repair & Service	13
4.5	Storage Conditions	13
5	Warranty	14
	Specifications	

1. SAFETY INFORMATION

REMEMBER: SAFETY IS NO ACCIDENT

These instructions contain both information and cautions that are necessary for the correct operation and maintenance of this product. It is recommended that you read the instructions carefully and ensure that the contents are fully understood.

Particular attention should be paid to the Precautions and Technical Specifications.

Please keep these instructions for future reference. Updated instructions and product information are available at:
www.martindale-electric.co.uk

1.1 Meaning of Symbols and Markings

 Caution - refer to instructions

 Equipment complies with relevant EU Directives

 End of life disposal of this equipment should be in accordance with relevant EU Directives.

1.2 Precautions

Please pay attention to the following cautions before use.

Cautions

The LM192 must only be used under the conditions and for the purposes for which it has been constructed and specified.

Before use, check the unit for cracks or any other damage. Make sure the unit is free from dust, grease and moisture. **Do not** use if damaged.

Avoid severe mechanical shock or vibration and extreme temperature.

To avoid possible corrosion from leaking batteries, remove the batteries if discharged or when the unit is not in use for an extended period.

Keep the plastic domed cosine corrector covered by the protective cover supplied when not in use.

2. INTRODUCTION

2.1 Inspection

Examine the shipping carton for any sign of damage. Inspect the unit and any accessories for damage. If there is any damage then consult your distributor immediately.

2.2 Description

The LM192 has the following functions and features:

- ◆ Light intensity measurement to 199900 lux, 19990 fc
- ◆ Spectral response: CIE photopic
- ◆ Hold, Max and Min functions
- ◆ Auto power off
- ◆ Low battery indication
- ◆ LCD display with backlight

2.3 Accessories

The LM192 comes with the following accessories:

- ◆ 2 x 1.5V AA batteries
- ◆ Protective case for safe storage
- ◆ Instructions

2.4 Battery Installation

Refer to Section 4.1 (Battery Replacement).

3

3. OPERATION

3.1 Description of Press Buttons & LM192 Elements

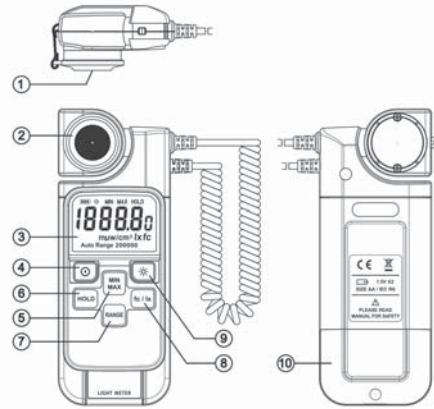

1		Sensor cap location
2		Sensor cap
3		LCD display
4		Turns the LM192 on/off
5		Select MIN/MAX measurement
6		Selects HOLD mode
7		Selects the preferred measuring range
8		Select Unit of measurement
9		Turns the backlight on/off
10		Battery cover

4

3.2 Description of LCD symbols

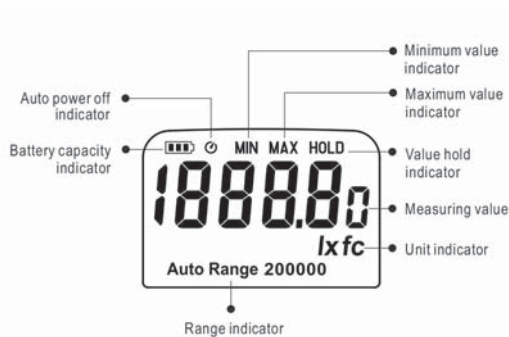

	Battery capacity indicator
	Auto power off is active
MIN	Minimum recorded reading is displayed
MAX	Maximum recorded reading is displayed
HOLD	Hold mode is active
lx fc	Units of measurement being displayed
Range	Range indicator
Auto Range	Auto range is active

3.3 Low Battery Indication

If the symbol is displayed, the battery needs replacing as measurement accuracy can no longer be guaranteed (See section 4.1 Battery Replacement).

5

3.4 Power On/Off

The LM192 will perform a self-test calibration check when powered up. This requires a completely dark environment so the protective sensor cap must be left on the sensor when the meter is powered up.

With the sensor cap fitted, press to start the self-test. **CAP** will flash on the LCD for a few seconds, followed by **CAL**. Once a value of **0.0lx** appears on the LCD, the calibration is complete. Remove the sensor cap and place it behind the sensor head on the fixing mount. The LM192 is now ready for use. To switch the LM192 off, press the button once.

Please note: If **ERR1** appears on the LCD during the self-test calibration, check that the sensor cap is securely fixed over the sensor and start the Power-On process again.

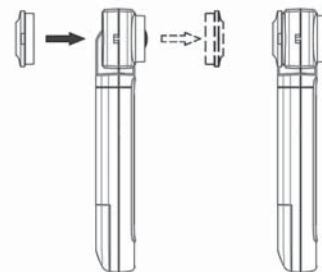

3.5 Auto Power Off (APO)

If the unit is inactive for a period of 30 minutes, it will automatically power off.

6

To disable this function, press and hold the **HOLD** button while pressing the **⓪** button. Release both buttons and the LM192 will perform the self-test. The **⓪** symbol will disappear from the LCD to confirm the auto power off is disabled.

3.6 Backlight

Press the **☀** button to turn on the display backlight. It will automatically turn off after 30 seconds if there is no further operation of the unit.

3.7 Min/Max

Press the **MIN/MAX** button to enable the **MIN/MAX** mode. By pressing the **MIN/MAX** button, the user can select between the minimum, maximum and current readings. If the LM192 is to be left monitoring lux levels over a period of time greater than 30 minutes, please note that Auto power off function will need to be disabled first (see section 3.5). Failure to disable the Auto power off will result in the LM192 switching off while recording lux levels. To exit **MIN/MAX** mode, hold the **MIN/MAX** button for 3 seconds and the MIN & MAX symbols will disappear to confirm the function is disabled.

3.8 Hold Mode

To enter the **HOLD** mode, press the **HOLD** button while in measurement mode. The **HOLD** symbol will appear on the LCD. To exit display hold, press the **HOLD** button again.

3.9 Unit of Measurement

Press the **fc/lx** button to change the unit of measurement between Foot Candle (**fc**) and Lux (**lx**).

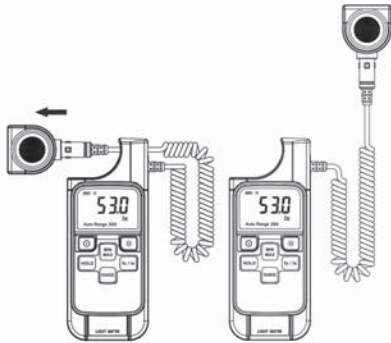

The Inverse-square Law

The illuminance E at a point on a surface varies directly with the intensity I of a point source, and inversely as the square of the distance d between the source and the point. If the surface at the point is normal to the direction of the incident light, the law is expressed by $E = I/d^2$.

Cosine Law

The illuminance on any surface varies as the cosine of the angle of incidence. The angle of incidence Θ is the angle between the normal to the surface and the direction of the incident light. The inverse-square law and the cosine law can be combined as $E = (I \cos \Theta)/d^2$.

Spectral Mismatch Correction Factor

Spectral mismatch is the result of the differences between the relative spectral responsivity of a light meter's sensor and the CIE

3.10 Auto/Manual Ranging

The LM192 defaults to Auto range and selects the lowest range available. The user can select a different measuring range by pressing the **RANGE** button.

The available ranges are:
 AUTO, 200, 2000, 20000, 200000 lx
 AUTO, 20, 200, 2000, 20000 fc

3.11 Measurement Mode

Hold the LM192 so the light sensor is directed toward the light source.

Press **fc/lx** to select **lux** or **fc** as required.
 Read the measured light intensity from the display.

3.12 Measurement Considerations

Keep the plastic domed sensor clean and free of scratches. It may be cleaned with a soft cloth and isopropyl alcohol.

The light level measurement should be taken at the application height. For light level measurements at a work station, the LM192 should be positioned at desk height. When measuring a work area or corridor, it should be placed on the floor.

It is important that the light source completely fills the sensor with minimal movement of the meter during measurement.

It is also advisable where possible to hold the LM192 away from your body when taking measurements to avoid reflections or creating a shadow on the sensor. The light sensing probe can be detached from the LM192. Avoid flexing the cable excessively at either end of the cable. For best accuracy, repeat the measurement several times to ensure that the light source has remained stable.

photopic curve it is designed to simulate, when the light meter is used to measure a light source with a different relative spectral distribution to that of the light source used to calibrate the light meter.

The LM192 has been calibrated against a standard tungsten light source at a correlated colour temperature of 2856K.

Where the best possible accuracy is required when measuring another light source type, it is suggested the LM192 should be calibrated for that light source type so as to determine the spectral mismatch correction factor (previously known as colour correction factor) for that light source type.

3.13 CIE Photopic Curve

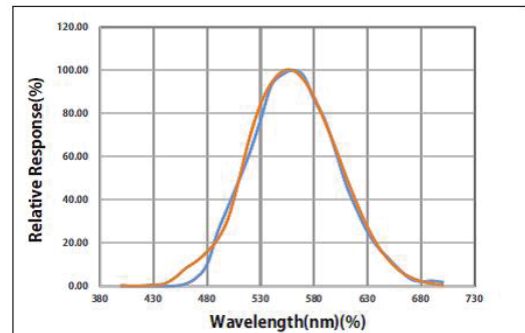

Wavelength (nm)	CIE photopic luminous efficiency coefficient V_{λ}	Photopic lumen/watt conversion factor
380	0.00004	0.027
390	0.00012	0.082
400	0.00040	0.270
410	0.00121	0.826
420	0.00400	2.73
430	0.01160	7.92
440	0.02300	15.71
450	0.03800	25.95
460	0.06000	40.98
470	0.09098	62.14
480	0.13902	94.95
490	0.20802	142.1
500	0.32300	220.6
510	0.50300	343.5
520	0.71000	484.9
530	0.86200	588.7
540	0.95400	651.6
550	0.99495	679.6
555	1.00000	683.0
560	0.99500	679.6
570	0.95200	650.2
580	0.87000	594.2
590	0.75700	517.0
600	0.63100	431.0
610	0.50300	343.5
620	0.38100	260.2
630	0.26500	181.0
640	0.17500	119.5
650	0.10700	73.08
660	0.06100	41.66
670	0.03200	21.86
680	0.01700	11.61
690	0.00821	5.61
700	0.00410	2.80
710	0.00209	1.43
720	0.00105	0.715
730	0.00052	0.355
740	0.00025	0.170
750	0.00012	0.082
760	0.00006	0.041

11

4. MAINTENANCE

4.1 Battery Replacement

The battery compartment is on the rear of the unit. To gain access, undo the retaining screw and lift the cover away from the back of the unit.

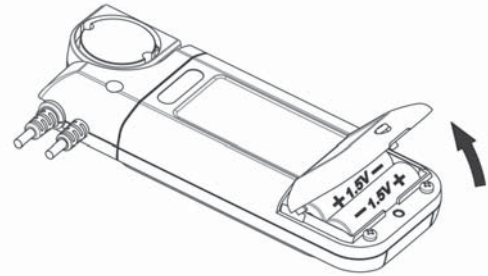

Replace with 2 new AA batteries (IEC LR6, NEDA 15A), observing correct polarity. Replace the battery cover.

Note: Do not mix old and new batteries.

4.2 Calibration

To maintain the integrity of measurements made using your instrument, Martindale Electric recommends that it is returned at least once a year to an approved Calibration Laboratory for recalibration and certification.

Martindale Electric is pleased to offer you this service.

Please contact our Service Department for details.

Email: service@martindale-electric.co.uk

Tel: 01923 650660

12

4.3 Cleaning

If contamination is found, clean with a damp soft cloth and if necessary a mild detergent or alcohol. Do not use abrasives, abrasive solvents, or detergents which can cause damage to the unit. If a mild detergent is used, the unit should subsequently be thoroughly cleaned with a water dampened soft cloth. After cleaning, dry and allow to remain in a dry environment for 2 hours before use.

4.4 Repair & Service

There are no user serviceable parts in this unit other than those that may be described in section 4. Return to Martindale Electric if faulty. Our service department will quote promptly to repair any fault that occurs outside the guarantee period.

Before the unit is returned, please ensure that you have checked the unit and batteries.

4.5 Storage Conditions

The instrument should be kept in warm dry conditions away from direct sources of heat or sunlight, and in such a manner as to preserve the working life of the unit. It is strongly advised that the unit is not kept in a tool box where other tools may damage it.

13

5. WARRANTY AND LIMITATION OF LIABILITY

This Martindale product is warranted to be free from defects in material and workmanship under normal use and service. The warranty period is 2 years and begins on the date of receipt by the end user. This warranty extends only to the original buyer or end-user customer, and does not apply to fuses, disposable batteries, test leads or to any product which, in Martindale's opinion, has been misused, altered, neglected, contaminated, or damaged by accident or abnormal conditions of operation, handling or storage.

Martindale authorised resellers shall extend this warranty on new and unused products to end-user customers only but have no authority to extend a greater or different warranty on behalf of Martindale.

Martindale's warranty obligation is limited, at Martindale's option, to refund of the purchase price, free of charge repair, or replacement of a defective product which is returned to Martindale within the warranty period.

This warranty is the buyer's sole and exclusive remedy and is in lieu of all other warranties, expressed or implied, including but not limited to any implied warranty of merchantability or fitness for a particular purpose. Martindale shall not be liable for any special, indirect, incidental or consequential damages or losses, including loss of data, arising from any cause or theory.

Since some jurisdictions do not allow limitation of the term of an implied warranty, or exclusion or limitation of incidental or consequential damages, the limitations and exclusions of this warranty may not apply to every buyer. If any part of any provision of this warranty is held invalid or unenforceable by a court or other decision-maker of competent jurisdiction, such holding will not affect the validity or enforceability of any other provision or other part of that provision.

Nothing in this statement reduces your statutory rights.

14



Specification
LM192
Light Meter



All specified accuracies are at 25°C ±1°C, <80% R.H. for 1 year
Temperature coefficient: 0.1 x (specified accuracy) per °C
(0-24°C, 26-50°C)

Accuracy:

±3% (calibrated to standard incandescent lamp 2856°K) Note 1

Angle deviation from cosine characteristics error:

10° ± 1% 30° ± 2%
60° ± 5% 80° ± 20%

Range: 0.0 to 199.9/1999/19990/199900 lx

0.0 to 19.9/199.9/1999/19990 fc

Resolution: 0.1lx, 0.1fc

Spectral response: CIE photopic Note 2

Light detector: Si photodiode

Note 1: The CIE standard illuminant A can be realized by means of CIE standard source A, which is defined as: A gas-filled tungsten-filament lamp operating at a correlated colour temperature of 2856K.

Note 2: The CIE photopic curve is an international standard for the colour response of the average human eye.



Specification
LM192
Light Meter

GENERAL

Display: liquid crystal display

Sampling rate: twice per second

Over range: OL is displayed

Power: 2 x 1.5V AA alkaline batteries (IEC LR6, NEDA 15A)

Continuous operating time: approximately 80 hours

Auto power off: after 30 minutes (can be disabled)

Dimensions: 169 (L) x 63 (W) x 37mm (H)

Weight: 185g including batteries

Includes: storage case, 2 x 1.5V AA batteries and instruction manual.

ENVIRONMENTAL

Temperature & Humidity (Operating): 0°C to 40°C ≤ 80% R.H.

(Storage): -10°C to 50°C ≤ 70% R.H. with batteries removed

Altitude: up to 2000m

Pollution degree: 2

EMC

Conforms to BS EN 61326-1

Check out what else you can get from Martindale:

- 18th Edition Testers
- Accessories
- Calibration Equipment
- Continuity Testers
- Electricians' Kits
- Environmental Products
- Full Calibration & Repair Service
- Fuse Finders
- Digital Clamp Meters
- Digital Multimeters
- Labels
- Microwave Leakage Detectors
- Motor Maintenance Equipment
- Multifunction Testers
- Non-trip Loop Testers
- Pat Testers & Accessories
- Phase Rotation Testers
- Proving Units
- Socket Testers
- Thermometers & Probes
- Test Leads
- Voltage Indicators
- Specialist Metrohm Testers (4 & 5kV)
- Specialist Drummond Testers



Martindale Electric Company Limited
Tel: +44(0)1923 441717 Fax: +44 (0)1923 446900
E-mail: sales@martindale-electric.co.uk
Website: www.martindale-electric.co.uk

© Martindale Electric Company Ltd. 2018
Registered in England No. 3387451. Rev 1 LIT192

