

# KEWTECH

KT45 digital LOOP PSC tester with 

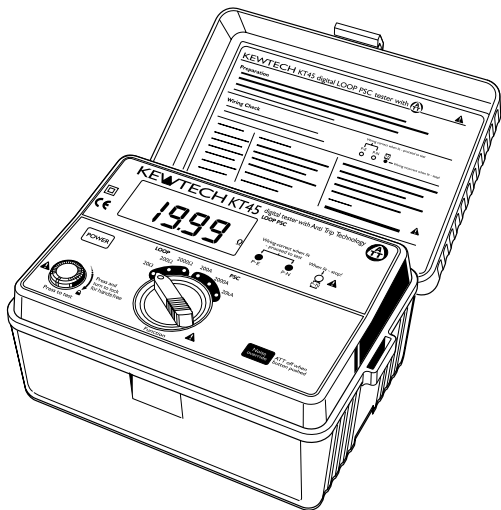

Instruction manual

---

## Contents

<b>1</b>	<b>Safety Notice</b>	<b>1</b>
<b>2</b>	<b>Features</b>	<b>3</b>
<b>3</b>	<b>Principles of measurement</b>	<b>10</b>
<b>4</b>	<b>Operating instructions</b>	<b>16</b>
<b>5</b>	<b>General</b>	<b>21</b>
<b>6</b>	<b>Battery Replacement</b>	<b>22</b>
<b>7</b>	<b>Servicing &amp; Calibration</b>	<b>23</b>

**The KT45 incorporates Anti Trip Technology (ATT) which electronically by-passes most RCDs at Distribution Boards. This saves time and money by not having to take the RCD out of circuit during testing and is a safer procedure to follow.**

**With the ATT function, a test current of 15mA or less is applied between line - earth. It enables LOOP measurement without tripping most RCDs.**

**If there is doubt as to whether this tester will by-pass a particular RCD, contact Kewtech with details of manufacturer, model no., rating and sensitivity.**

Please read this instruction manual carefully before using this instrument.

## I Safety Notice

Electricity can cause severe injuries even with low voltages or currents. Therefore it is extremely important that you read the following information before using this Tester.

- 1.1 This instrument must only be used by a competent trained person and in strict accordance with the instructions. Kewtech will not accept liability for any damage or injury caused by misuse or non-compliance with instructions or safety procedures.
- 1.2 This instrument is only intended for single phase operation, 230V AC+10%-15% phase to earth or phase to neutral operation. Although fully protected (no bangs), it must never be connected phase to phase (400 VAC).
- 1.3 When conducting a test, particularly on earth spikes, do not touch any exposed metal work. This is because the earth has a current flowing through it for the duration of the test.
- 1.4 **Never open the instrument case** (except for battery replacement and in this case disconnect all leads first)- there are dangerous voltages present. Only trained, competent Electronic engineers should open the case. Send the unit to Kewtech, if a fault develops.
- 1.5 This instrument is primarily protected by HRC Ceramic fuses. Do not attempt to replace them if they fail. If they do, contact Kewtech.
- 1.6 If the overheat symbol appears in the display, disconnect the instrument from the mains and allow to cool down.
- 1.7 When testing, always be sure to keep your fingers behind the safety barriers on the test leads.
- 1.8 Always inspect your Instrument and test leads before use for any sign of abnormality or damage. If any abnormal conditions exist (broken test leads, cracked case, display faulty, inconsistent readings, etc) do not attempt to take any

measurements. Return to Kewtech for repair.

- I.9 This meter has been designed with your safety in mind. However, no design can completely protect against incorrect use. Electrical circuits can be dangerous and/or lethal when a lack of caution or poor safety practice is used. Use caution in the presence of voltages above 33V as these pose a shock hazard.
- I.10 Pay attention to cautions and warnings which will inform you of potentially dangerous procedures.
- I.11 Never assume an installation circuit is not live. Confirm it is de-energized before commencing testing using a suitable tester.
- I.12 Replace worn and/or damaged leads with new ones approved by Kewtech immediately. Only use accessories recommended by Kewtech as they are designed to work with the tester. The use of any other items is prohibited as they may not have the same safety features built in, and may degrade performance.
- I.13 Users of this equipment and/or their employers are reminded that Health and Safety Legislation require them to carry out valid risk assessments of all electrical work so as to identify potential sources of electrical danger and risk of electrical injury such as from inadvertent short circuits. Where the assessments show that the risk is significant then the use of fused test leads constructed in accordance with HSE guidance note GS38 Electrical test Equipment for use by Electricians should be used.

## 2 Features

### 2-1 Instrument layout

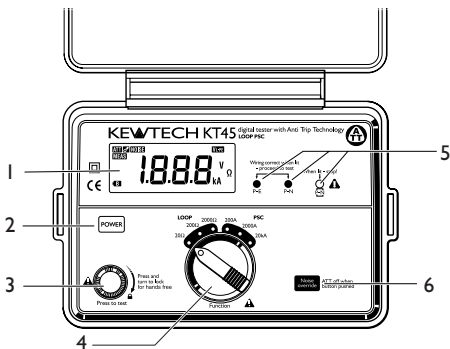

Fig 1

1.....LCD

2.....Power Switch

3.....Test Button

4.....Function / Range Switch

5.....Wiring Check LEDs

LED indication of correct polarity is that the P-E and P-N LEDs are lit. P and N are reversed when the  reverse LED is lit.

6.....Noise override Switch

LCD display



Fig 2

## 2-2 Accessories

▲KAMP11UK mains test lead with IEC Connector

▲ACC016E Distribution board fused test lead

(Fuse: 10A/600V fast acting ceramic)

▲Test lead carry pouch

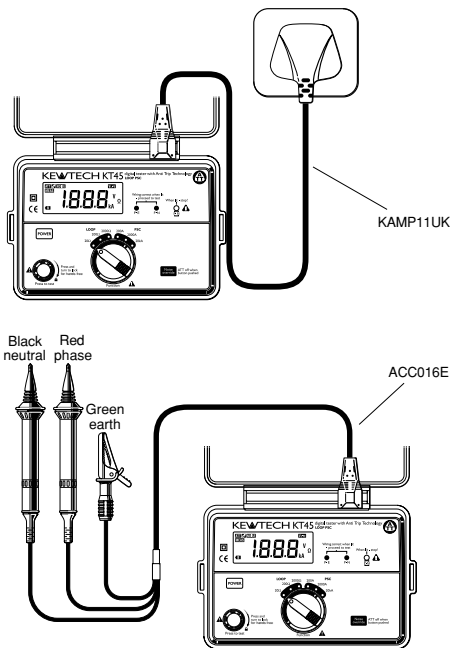



Fig 3

## 2-3 Features

- ▲ ATT (Anti Trip Technology) In the ATT mode, LOOP measurement can be done without tripping RCDs rated at 30mA or more.
- ▲ Wiring Check Three LEDs indicate if the wiring of the circuit under test is correct.
- ▲ Over temperature protection Detects overheating of the internal resistor displaying a warning symbol () and automatically halting further measurements.
- ▲ Main Voltage Indication When connecting Test Lead to circuit, voltage between L- PE is displayed. If the voltage is lower than 100V, displayed as "V L- PE Lo". If the voltage is between 260V and 300V, voltage and "V L- PE Hi" is displayed alternately. When the voltage is 300V or more, "V L- PE Hi" is displayed.
- ▲ Low battery warning "  "symbol appears in the display if the battery voltage drops below 8V(ATT 9.2V).
- ▲ Auto power off Automatically switches the instrument off after approximately 10 minutes.

## 2-4 Measurement specification

### Loop impedance

Range	Measuring range	Nominal test current at 0Ω external loop: Magnitude/Duration	Intrinsic accuracy
20Ω	0.00-19.99Ω	25A/10ms	
200Ω	0.0-199.9Ω	2.3A/20ms	±(3%rdg+4dgt)
2000Ω	0-1999Ω	15mA/360ms	
20Ω	0.00-19.99Ω		
(ATT) (*1)L-N<20Ω		P-N:25A/30ms	±(3%rdg+6dgt)
200Ω	0.0-199.9Ω	N-E:11mA/approx. 2s	
(ATT) (*1)L-N<20Ω			

### Prospective Short-circuit Current

Range	Measuring range	Nominal test current at 0Ω external loop: Magnitude/Duration	Intrinsic accuracy
200A	0.0-199.9A	2.3A/20ms	PSC accuracy is derived from the loop impedance accuracy
2000A	0-1999A	25A/10ms	
20kA	0.00-1.99kA	25A/10ms	
200A	0.0-199.9A		PSC(ATT)
(ATT) (*1)L-N<20Ω			accuracy is
2000A	0.0-1999A	P-N:25A/30ms	derived from the
(ATT) (*1)L-N<20Ω		N-E:11mA/approx. 2s	loop (ATT)
20kA	0.00-1.99kA		impedance
(ATT) (*1)L-N<20Ω			accuracy

(\*1): If the impedance between L-N is 20Ω or more, "no" is displayed on the LCD and no measurement can be made. In this case, disables ATT function and make measurement.

## Voltage

Measuring range	Intrinsic accuracy
100-300V (*2):	$\pm(2\%rdg+4dgt)$

(\*2): The voltage and "V L- PE Hi" is displayed on the LCD alternately when the voltage is 260V or more and under 300V.

### 2.5 Reference conditions

Ambient temperature:	$23\pm 5^{\circ}\text{C}$
Relative humidity:	$60\pm 15\%$
Nominal system voltage and frequency:	230V, 50Hz
Altitude:	Less than 2000m

## 2-6 Operating error

### Loop impedance(IEC61557-3)





Range	Operating range compliant with EN61557-3 operating error
20Ω	0.35 to 19.99Ω
200Ω	20.0 to 199.9Ω
2000Ω	200 to 1999Ω

The influencing variations used for calculating the Operating error are:

Ambient temperature:	0° and 35°C
Phase angle:	0° to 18°C
System frequency:	49.5Hz to 50.5Hz
System voltage:	195V to 253V
Supply voltage:	8V to 13.8V

## 2.7 General specification



Operating temperature and humidity.	0 to 40°C, relative humidity 85% or less, no condensation.
Storage temperature and humidity.	-20 to +60°C, relative humidity 85% or less, no condensation.
Battery type	Eight AA R6 or LR6 batteries
Measurement times:	approx 1500 times or more. (ATT 500 times or more.)
Dimensions:	175 x 115 x 85.7mm
Weight:	810g
Maximum altitude:	2000m
Over range indication:	'OL'

Input voltage greater than 260V indication:	'VLP-E Hi' and voltage(alternating)
Input voltage greater than 300V indication:	'VLP-E Hi'
Over temperature indication	
Low battery indication	
ATT mode indication	
Noise indication (ATT Mode)	

## 2.8 Applied standards

Instrument operating standard	IEC/EN61557-1,3(1997)
Safety standard	IEC/EN 61010-1(2001), CATIII (300V) -Instrument IEC/EN 61010-031(2001), CATIII (300V)-Test Lead
Protection degree	IEC 60529(1989 + A1)IP40

This manual and product may use the following symbols adopted from International Safety Standards;

- CAT.III Designed to protect against transient overvoltages in a building wiring installation (low-voltage distribution level)
-  Equipment protected throughout by DOUBLE INSULATION or REINFORCED INSULATION;
-  Caution (refer to accompanying documents)

### 3 Principles of Measurement

#### 3.1 Principles of Measurement (Fault Loop Impedance)

If an electrical installation is protected by over-current protective devices including circuit breakers or fuses, the earth loop impedance should be measured.

In the event of a fault the earth fault loop impedance should be low enough (and the prospective fault current high enough) to allow automatic disconnection of the electrical supply by the circuit protection device within a prescribed time interval. Every circuit must be tested to ensure that the earth fault loop impedance value does not exceed that specified or appropriate for the over-current protective device installed in the circuit.

KT45 takes a current from the supply and measures the difference between the unloaded and loaded supply voltages. From this difference it is possible to calculate the loop resistance. For a TT system the earth fault loop impedance is the sum of the following impedances;

- ▲ Impedance of the power transformer secondary winding.
- ▲ Impedance of the phase conductor resistance from the power transformer to the location of the fault.
- ▲ The impedance of the protective conductor from the fault location to the earth system.
- ▲ Resistance of the local earth system (R).
- ▲ Resistance of the power transformer earth system (R<sub>0</sub>).

The figure below shows in marked line the Fault loop impedance for TT system.

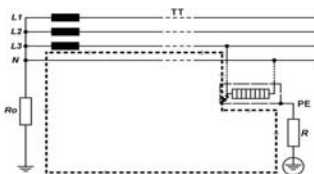

Fig 4

For TN systems the earth fault loop impedance is the sum of the following impedances.

- ▲ Impedance of the power transformer secondary winding.
- ▲ Impedance of the phase conductor from the power transformer to the location of the fault.
- ▲ Impedance of the protective conductor from the fault location to the power transformer.

The figure below shows in marked line the Fault loop impedance for TN system.

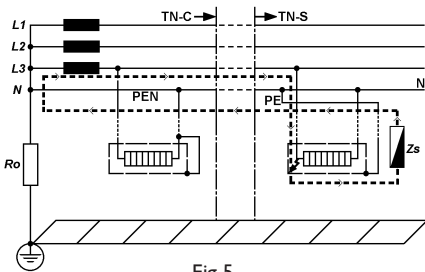

Fig 5

In accordance with the international standard IEC 60364 for a TT system the following condition shall be fulfilled for each circuit.

$$R_A \text{ must be } \leq 50 / I_a$$

where;

$R_A$  is the sum of the resistances of the local earth system  $R$  and the protective conductor connecting it to the exposed conductor part. 50V is the maximum voltage limit (it may be 25V in certain circumstances).

$I_a$  is the value of current that causes automatic disconnection of the protective device within 5 seconds.

When the protective device is a residual device (RCD),  $I_a$  is the rated residual operating current  $I_{\Delta n}$ . For example in a TT system protected by an RCD the maximum RA values are as follows:

<b>Rated residual operating current <math>I_{\Delta n}</math> mA</b>	<b>10</b>	<b>30</b>	<b>100</b>	<b>300</b>	<b>500</b>	<b>1000</b>
Ra (at 50V) $\Omega$	5000	1667	500	167	100	50
Ra (at 25V) $\Omega$	2500	833	250	83	50	25

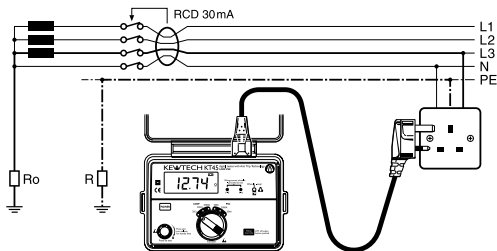

Fig 6

For this example the maximum value is  $1667\Omega$ , the loop tester reads  $12.74\Omega$  and consequently the condition  $RA \leq 50/I_a$  is met. It is also important to test the operation of the RCD using a dedicated RCD tester in accordance with the international standard IEC60364 for a TN system. The following condition shall be fulfilled for each circuit.

$Z_s \leq U_0/I_a$  where  $Z_s$  is the earth fault loop impedance voltage is the nominal voltage between phase and earth and  $I_a$  is the current that causes the automatic disconnection of the protective device within the time stated in the following table.

<b>U<sub>0</sub> (Volts)</b>	<b>T (seconds)</b>
120	0.8
230	0.4
400	0.2
>400	0.1

Note:

▲When the protective device is a residual current device (RCD),  $I_a$  is the rated residual operating current  $I_{\Delta n}$ .

For instance in a TN system with a nominal mains voltage of  $U_0 = 230V$  protected by type gG fuses the  $I_a$  and maximum  $Z_s$  values could be:

Rating (A)	Disconnecting Time 5s		Disconnecting Time 0.4s	
	$I_a$ (A)	$Z_s$ ( $\Omega$ )	$I_a$ (A)	$Z_s$ ( $\Omega$ )
6	28	8.20	47	4.90
10	46	5.00	82	2.80
16	65	3.60	110	2.10
20	85	2.70	147	1.56
25	110	2.10	183	1.25
32	150	1.53	275	0.83
40	190	1.21	320	0.72
50	250	0.92	470	0.49
63	320	0.71	550	0.42
80	425	0.54	840	0.27
100	580	0.39	1020	0.22

If the prospective fault current is measured, its value must be higher than the  $I_a$  value of the protective device concerned.

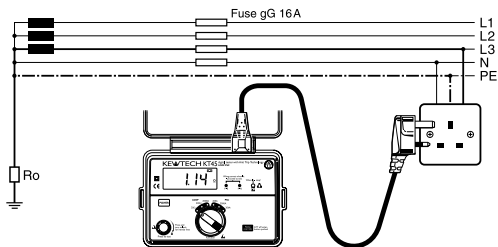

Fig 7

The maximum value of  $Z_s$  for this example is  $2.1\Omega$  (16 amp gG fuse, 0.4 seconds). The loop tester reads  $1.14\Omega$  and consequently the condition  $Z_s \leq U_o/I_a$  is met.

### 3.2 Principles of the measurement (line impedance and prospective short circuit current)

Line impedance on a single phase system is the impedance measured between phase and neutral terminals.

Measurement principles for line impedance are exactly the same as for earth fault loop impedance measurement with the exception that the measurement is carried out between phase and neutral.

The protective short circuit or fault current at any point within an electrical installation is the current that would flow in the circuit if no circuit protection operated and a complete (very low impedance) short circuit occurred.

The value of this fault current is determined by the supply voltage and the impedance of the path taken by the fault current. Measurement of prospective short circuit current can be used to check that the protective devices within the system will operate within safety limits and in accordance with the safe design of the installation. The breaking current capacity of any installed protective device should be always higher than the prospective short circuit current.

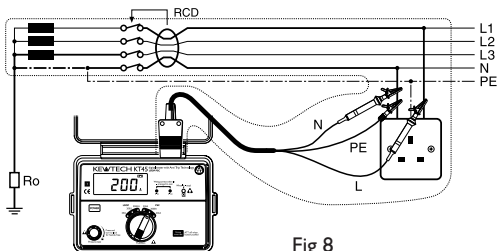

Fig 8

## 4. Operating instructions

### 4.1 Initial Checks: to be carried out before any testing;

#### 4.1.1 Preparation

Always inspect your test instrument and lead accessories for abnormality or damage-If abnormal conditions exist DO NOT PROCEED WITH TESTING. Have the instrument checked by Kewtech.

- (1) Operate the Power button and turn on the instrument.  
Turn the Function switch and set it to any range at the LOOP or PSC.
- (2) Insert the Test Lead into the instrument.(Fig.3)
- (3) Pressing the Noise override switch disables ATT mode. Then the "ATT" mark on the LCD will disappear.
  - ▲ ATT mode enables a measurement without tripping the RCDs with the rated residual current of 30mA or more.
  - ▲ Measurement in ATT mode requires longer time than that is required for the other measurements (approx. 10 sec). When measuring a circuit with a large electrical noise, the 'NOISE' mark is displayed on the LCD and the measurement time will be extended to 20 sec. When the noise is so great as to influence the test result the 'NOISE' symbol will flash and --- will appear in the screen. If the 'NOISE' mark is displayed on the LCD, it is recommended to disable the ATT mode and take a measurement (RCDs may trip).
  - ▲ If the impedance of  $20\Omega$  or more exists between L-N, "no" is displayed on the LCD and no measurement can be made. In this case, disable the ATT function and make measurement. When a large contact voltage exists in the

circuit under test, "no" is displayed on the LCD and no measurement can be made. In this case, disable the ATT function and make measurement. Be aware that if the ATT mode is disabled, RCDs may trip.

- ▲ ATT mode is automatically enabled after one measurement when making a measurement with ATT mode disabled.

#### 4.1.2 Wiring Check

After the connection, ensure that the LEDs are in the following status before pressing the test button.

- ▲ P-E Green LED must be ON
- ▲ P-N Green LED must be ON
- ▲ Red LED must be OFF

If the above sequence is NOT displayed or the RED LED is on for any reason, DO NOT PROCEED AS THERE IS INCORRECT WIRING. The cause of the fault must be investigated and rectified.

#### 4.1.3 Voltage Measurement

When the instrument is first connected to the system, it will display the phase-earth voltage which is updated every 1s. This mode is cancelled the first time the test button is pressed. If this voltage is not normal or as expected, DO NOT PROCEED.

NOTE: This is a single phase (230V AC) instrument and **under no circumstances** should it be connected to 2- phases or a voltage exceeding 230VAC+10%.

If the input voltage is greater than 260V the display will indicate 'VP-E Hi' and Loop or PSC measurements can not be made even if the Test button is pressed.

## 4.2 Measurement of Loop impedance

### a. Loop Impedance at Mains Socket Outlet

Connect the mains lead to the IEC socket of the instrument. Plug the molded plug of the mains lead into the socket to be tested.

Carry out the initial checks.

Press the test button. A beep will sound as the test is conducted and the value of loop impedance will be displayed. If the display shows 'OL' then this usually means the value measured exceeds the range selected, e.g. if the  $20\Omega$  range was selected then the loop impedance is greater than  $19.99\Omega$  and you must switch up a range to the  $200\Omega$  range.

### b. Loop impedance at the distribution board

**Warning: Although it is fully protected (no bangs), never connect phase to phase (400VAC) to this instrument**

Select the  $20\Omega$ ,  $200\Omega$  or  $2000\Omega$  range as required. Connect the distribution board lead model ACC016E to the IEC socket on the instrument.

Connect the green crocodile clip of the ACC016E to the earth, the black neutral lead to the neutral of the distribution board and the red phase lead to 1 phase of the distribution board.

Carry out the initial checks

Press the test button. A beep will sound as the test is conducted and the value of loop impedance will be displayed. When disconnecting from the distribution board, it is good practice to disconnect the phase first.

### c. Loop impedance at 3-phase equipment

Use the same procedure as (b) ensuring only **1-phase is connected at a time** i.e. FIRST test-red prod to phase 1, black prod to neutral, green crocodile clip to earth;  
SECOND test-red prod to phase 2, black prod to neutral, green crocodile clip to earth etc.

### d. The ACC016E can also be used for testing at light fittings.

Testing as described in (a), (b), (c) and (d) will measure the Phase-Earth loop impedance. If you wish to measure the Phase-Neutral loop impedance in items (b), (c), (d), then same procedure should be followed except the earth clip should be connected to the neutral of the system i.e. the same point as the black neutral probe.

If the system has no neutral then you must connect the black neutral probe to the earth i.e. same point as the green earth clip. This will only work if there is no RCD in this type of system.

## 4.3 Measurement of PSC (Prospective Short Circuit Current)

**Warning: Although it is fully protected (no bangs), never connect phase to phase (400VAC) to this instrument.**

This is normally measured at the distribution board between the phase and neutral.

Connect the ACC016E distribution board lead to the IEC socket on the instrument

Connect the red phase probe of the ACC016E to the phase of the system, the **black probe to the neutral of the system** and

the **green crocodile clip to the neutral of the system**

Carry out the initial checks Press the test button. A beep will sound as the test is conducted and the value of PSC will be displayed.

It is good practice to disconnect the phase lead first

**Note:**



PSC function has a power factor correction of 0.84.

$$\text{PSC} = \frac{\text{Voltage(V)}}{\text{LOOP}(\Omega)} \times 0.84$$

If the PSC ranges are selected whilst connected to a socket outlet via the mains lead KAMPI IUK, a test will take place between Phase and Earth due to the fixed wiring of the moulded mains plug i.e. a **Phase-Earth fault current test**.

When measuring the Phase-Earth fault current with the ATT mode activated, RCD won't trip as well as at the LOOP test.

## 5 General

- 5.1 If the symbol (  ) appears, this means that the test resistor is too hot and the automatic cut out circuits have operated. Allow the instrument to cool down before proceeding. The overheat circuits protect the test resistor against heat damage.
- 5.2 The test button may be turned clockwise to lock it down. In this auto mode, when using distribution board lead ACC016E, tests are conducted by simply disconnecting and reconnecting the red phase prod of the ACC016E avoiding the need to physically press the test button i.e. 'hands free'.
- 5.3 When the display shows the low battery indication, (  ), disconnect the test leads from the instrument. Remove the battery cover and the batteries.
- 5.4 If at any time during testing there is a momentary degradation of reading, this may be due to excessive transients or discharges on the system or local area. Should this be observed, the test should be repeated to obtain a correct reading. If in doubt, always contact Kewtech.

## 6 Battery replacement

When the display shows the low battery indication, ( **B** ), disconnect the test leads from the instrument. Remove the battery cover and the batteries.

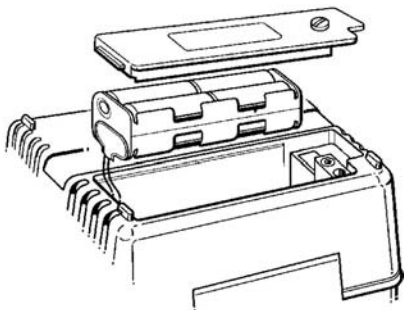

Fig 9

### **⚠ DANGER**

Never open the battery compartment cover while making measurement. To avoid possible electrical shock, disconnect the test probe before opening the cover for battery replacement.

### **⚠ CAUTION**

Install batteries in correct polarity as marked inside.

1. Disconnect Test Lead from the instrument.
2. Open the battery compartment cover by unscrewing the metal captive screw to reveal battery compartment. Always replace all eight batteries with new ones at the same time.  
Battery type: Eight AA R6 or LR6 batteries

## 7 Servicing and Calibration

If this tester should fail to operate correctly, return it to Kewtech marked for the attention of the Service Department. stating exact nature of fault. Make sure that:

- a. operating instructions have been followed
- b. leads have been inspected
- c. the unit is returned with all accessories

Regular re-calibration is recommended for this instrument. We recommend that with normal use, the instrument is calibrated at least once in every 12 month interval. When this is due for re-calibration return it to Kewtech marked for the attention of the Calibration Department and be sure to include all accessory leads, as they are part of the calibration procedure. The mains lead supplied with this instrument (model KAMP11UK) for testing at sockets is part of the instrument. It directly affects the accuracy of the loop and PSC readings. As such always keep it with the instrument and remember to return it with the instrument when servicing and calibration is required. In a similar way the ACC016E is part of the instrument. The ACC016E leads are fused and fuses are rated at 10A/600V high rupture ceramic types. If they should blow always return the instrument to Kewtech for checking. The fuses are special and should only be replaced by equivalent types. Returning the product to Kewtech will ensure this. If other leads are used then reading may not be correct unless they are calibrated with the instrument.

If this product needs cleaning use a damp cloth to wipe its surfaces.

DO NOT use strong cleaning agents as these may damage the plastic surfaces. Kewtech reserve the right to change specifications and design without notice and without obligation.

## Case, strap, shoulder-pad and test lead pouch assembly

Assemble the shoulder strap through the case lugs and the test lead pouch in the following sequence:

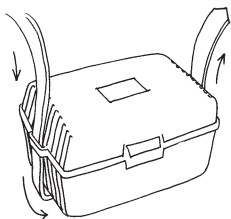

1 Pass the strap **down** through the first lug, under the case and **up** through the other lug.

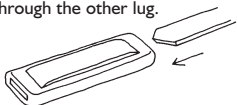

2 Slide the shoulder pad onto the strap

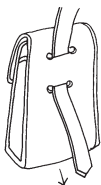

3 Feed the strap **down** through the slots in the back of the test lead pouch.

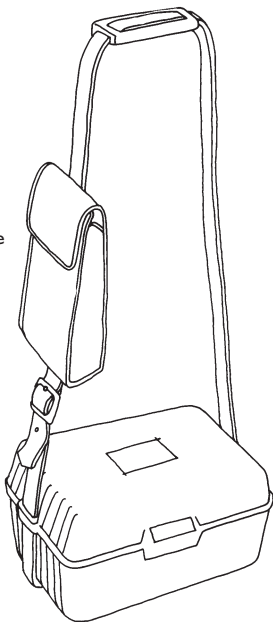

4 Pass the strap through the buckle, adjust the strap for length and secure.

Distributor

Kewtech Corporation Limited  
St. Catherine's Grove  
Lincoln LN5 8NA  
[www.kewtechcorp.com](http://www.kewtechcorp.com)

