

Foodpro

食品安全型红外温度计

User Guide 使用手册

Fluke Corporation
P.O. Box 9090
Everett, WA
98206-9090

Fluke Europe B.V.
P.O. Box 1186
5602 BD Eindhoven
The Netherlands

MC
京制00000298号



2/2006 2514848
©2006 Fluke Corporation
All rights reserved. Printed in China.
Made in China.
制造商: 北京雷泰光电技术有限公司
北京市朝阳区酒仙桥路14号兆维华灯大厦一层
电话: 010-64392255

Tous droits ont réservés. Fait dans la Chine. Imprimé dans la Chine.
Bien reservado. Hecho en la China. Impreso en la China.
www.fluke.com

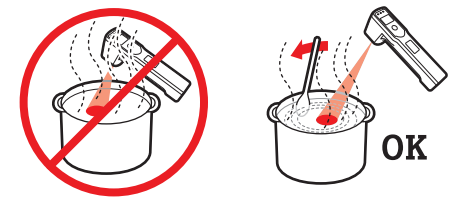
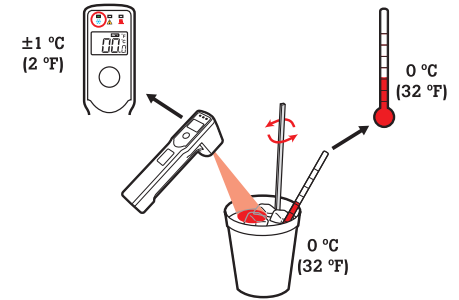
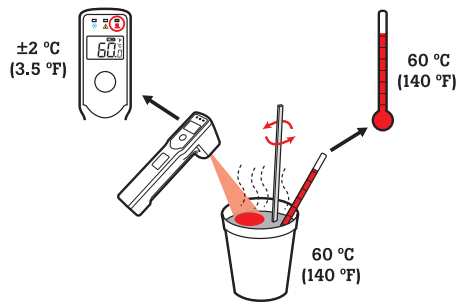
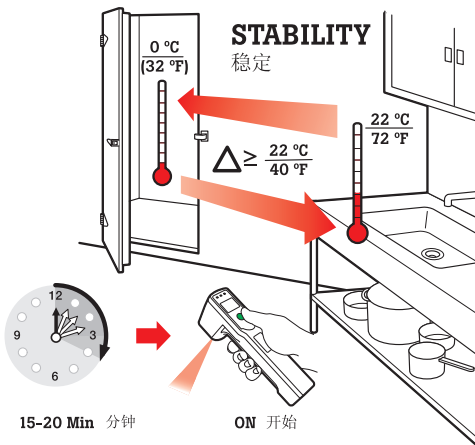

Temperature Range	Temperaturbereich	Etendue de mesure	Range de Temperatura	Rango de Temperatura	測定温度範囲	-30 °C to 200 °C (-20 °F to 400 °F)	温度范围	-30 °C ~ 200 °C (-20 °F ~ 400 °F)
Accuracy Assumes ambient operating temperature of 23 °C ± 2 °C (73 °F ± 4 °F)	Genauigkeit bei einer Umgebungstemperatur von 23 °C ± 2 K	Précision par 23 °C ± 2 K ambient	Precisão Assume a temperatura operacional ambiente e 23 °C ± 2 °C (73 °F ± 4 °F)	Precisión Suponiendo Temperatura Ambiente de Operación de 23 °C ± 2 °C (73 °F ± 4 °F)	測定精度 (23°C ± 2°Cでの値)	Between 0 °C and 65 °C (32 °F to 150 °F): ±1 °C (±2 °F) Below 0 °C (32 °F): ±1 °C (±2 °F) ±0.1 ° Above 65 °C (150 °F): ±1.5 % of reading	精度 环境为23°C ± 2°C 或73°F ± 4°F	0 °C ~ 65 °C (32 °F ~ 150 °F): ±1 °C (±2 °F) 低于 0 °C (32 °F): ±1 °C (±2 °F) ±0.1 度/度 高于 65 °C: 读数的 ±1.5 %
Response Time	Ansprechzeit	Temps de réponse	Tempo de Resposta	Tiempo de Respuesta	応答速度	<500 ms after initial reading	响应时间	<500ms, 在初始读数后
Spectral Response	Spektrale Empfindlichkeit	Réponse spectrale	Resposta Espectral	Respuesta Espectral	応答波長	8-14 microns	响应波长	8-14um
Emissivity	Emissionsgrad	Emissivité	Emissividade	Emisividad	放射率補正	Pre-set for Food Service Applications	发射率	为食品应用预设
Optical Resolution (D:S)	Optische Auflösung (E:M)	Résolution optique (E:S)	Resolução Óptica (D:S)	Resolución Óptica (D:S)	D:S比	2.5:1 @ 90% energy, typical	光学分辨率(D:S)	2.5:1 (90%能量, 典型值)
Typical Working Range (target illumination)	Typische Messentfernung (Messfleckbeleuchtung)	Distance de mesure classique (Eclairage de la cible)	Range de Operação Típica (iluminação do alvo)	Rango típico de Aplicación (iluminación del objetivo)	標準測定距離	≈25 mm to 250 mm (=1 in to 10 in)	典型的工作范围 (目标照明)	约从25mm到250mm
Repeatability	Reproduzierbarkeit	Reproductibilité	Repetibilidade	Repetibilidad	反復精度	Within accuracy specifications of the unit	重复性	小于最大误差
Ambient Operating Range	Umgebungs-temperaturbereich	Température ambiante	Range Operacional do Ambiente	Temperatura Ambiente de Operación	動作環境温度	0 °C to 50 °C (32 °F to 122 °F)	操作环境温度范围	0 °C ~ 50 °C (32 °F ~ 122 °F)
Relative Humidity	Relative Luftfeuchte	Humidité relative	Umidade Relativa	Humedad Relativa	相对湿度	10-90 % RH noncondensing, @ up to 30 °C (86 °F)	相应湿度	10~90%, 在30°C, 无凝露
Storage Temperature	Lagertemperatur	Température de stockage	Temperatura de Armazenamento	Temperatura de Almacenamiento	保存温度	-20 °C to 60 °C (-4 °F to 140 °F)	储存温度	-20 °C ~ 60 °C (-4 °F ~ 140 °F)
Weight/Dimensions (with battery)	Abmessungen/Masse (inklusive Batterien)	Dimensions/Masse (avec les piles)	Peso/Dimensões (com bateria)	Peso/Dimensiones (con bateria)	重量/寸法	150 mm x 30 mm x 50 mm (5.88 in x 1.25 in x 2 in) 150 g (0.33 lbs)	重量/尺寸带(电池)	150mmX30mmX50mm, 150 克
Power	Spannungsversorgung	Alimentation	Alimentação	Alimentación	電源	1 AA alkaline battery	电源	一节五号 AA 电池
Battery Life	Batterielebensdauer	Autonomie des piles	Durabilidade da Bateria	Duración de la Bateria	バッテリー駆動時間	10 hours minimum @ 23 °C (73 °F)	电池寿命	在23°C (73°F)时, 至少10小时
Display Resolution	Anzeigenaufösung	Résolution d'indication de température	Resolução do Display	Resolución en Pantalla	表示分辨率	4 digits, 0.1 °C (0.2 °F)	显示分辨率	4位, 0.2°C (0.5°F)
Display Hold	Anzeigenhaltezeit	Durée d'affichage	Espera do Display	Retención de Lectura	ホールド時間	7 sec	显示保持	7秒
Standards	Standards	Standards	Padrões	Estándares	適合規格	Conforms to: • EN61326-1 Electromagnetic Emissions and Susceptability, Criteria B • EN61010-1 General Safety	标准	符合: EN61326-1 电磁辐射和响应标准 EN61010-1 通用安全标准
Environmental Sealing	Schutzgrad	Degré de protection	Vedação Ambiental	Sellado Ambiental	保護等級	IP54 Sealing (hand washable, non submersible)	环境密封	IP54, (可以手擦洗, 不能浸液)
Minimum Target Size	Kleinste Messfleckgröße	Taille minimale du spot	Tamanho Mínimo do Alvo	Tamaño Mínimo de Objetivo	最小スポットサイズ	≈12 mm (≈0.5 in)	最小目标尺寸	约12mm
Illumination to IR Channel Offset	Offset: Messkanal zu Beleuchtung	Offset: canal infrarouge pour éclairage	Iluminação para o Deslocamento (Offset) do Canal IV	Desalineación Entre Canales de Iluminación e Infrarrojo	照準中心軸オフセット	13 mm (0.52 in)	照明与IR的偏差	13mm
Certifications	Zertifizierung	Certification	Certificado	Certificacaciones	認證	CE NSF	认证	CE NSF CMC

HACCP ✓

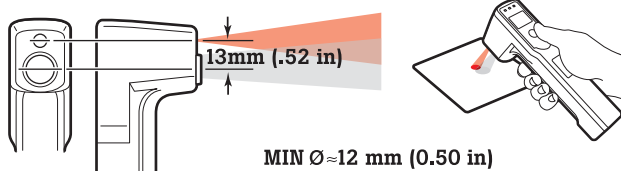
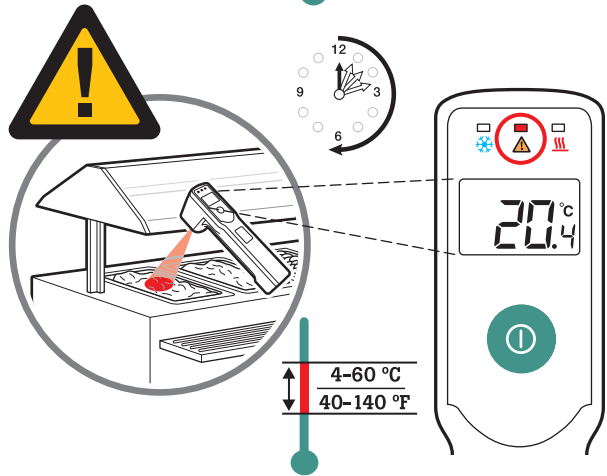
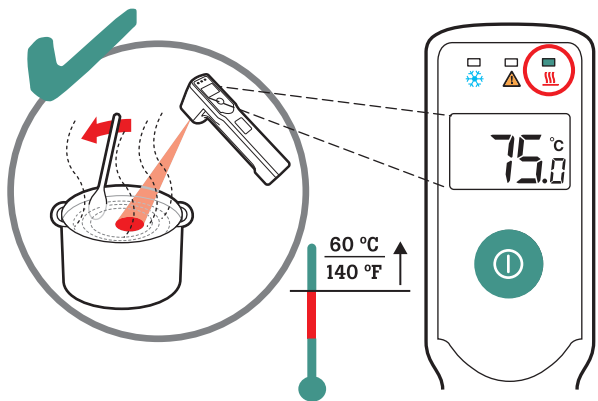
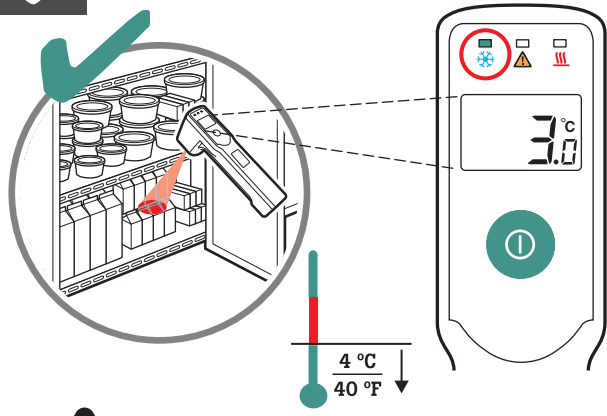
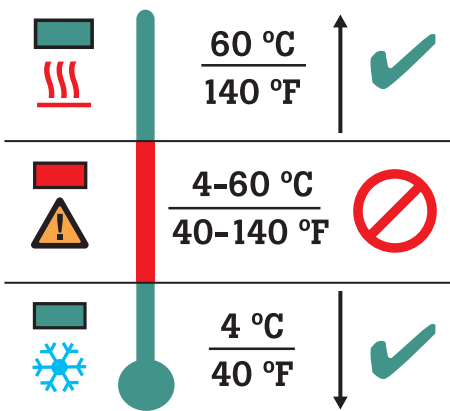

1 °C – 4 °C
(34 °F – 39 °F)

1 °C – 4.5 °C
(34 °F – 40 °F)

0 °C – 4 °C
(32 °F – 39 °F)

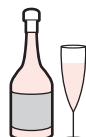
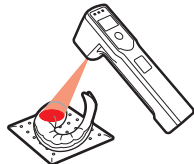

14 °C – 19 °C
(57 °F – 66 °F)

9 °C – 13 °C
(48 °F – 55 °F)

4 °C – 8 °C
(39 °F – 46 °F)

MIN 最小

MAX 最大



2 °C – 4 °C
(36 °F – 39 °F)

≤ -20 °C
(-5 °F)

-18 °C – 12 °C
(0 °F – 10 °F)

-15 °C – 20 °C
(59 °F – 68 °F)

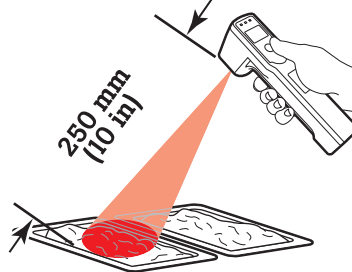
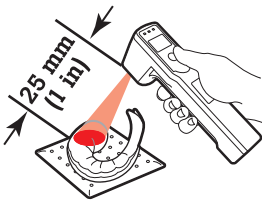

HACCP Zone Indicators / Indicateur zone HACCP
HACCP-Bereichsanzeige / Indicadores de Zona APPCC HACCP
HACCP ゾーン表示 / HACCP 区域指示灯

C°/F° Indicator / Affichage C°/F°
C°/F°-Anzeige / Indicador C°/F°
Indicador C°/F° / 温度表示 (C°)
C°/F° 指示灯

Low Battery Icon / Icône Etat des piles
Batteriezustandsanzeige / Icono de Bateria
Baja / Ícone de bateria com carga baixa
バッテリー アイコン 電池电量不足 图标

ON (Measure) / ON (Mesure) / ON (Messen)
ON (Medición) / ON (Medida)
ON 测温 ボタン / ON (測量)

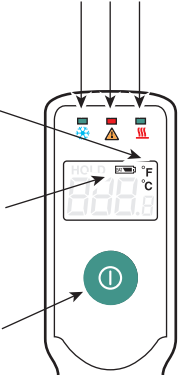

Target Illumination / Eclairage de la cible Optique
Messfleckbeleuchtung / Iluminación del Objetivo
Iluminação alvo / マーカー (照準) / 目标照明

Window for IR Optics / Sonde
Infraoptique / Ventana de Óptica IR
Janela para óticos IR

红外测
量窗口
レンズ

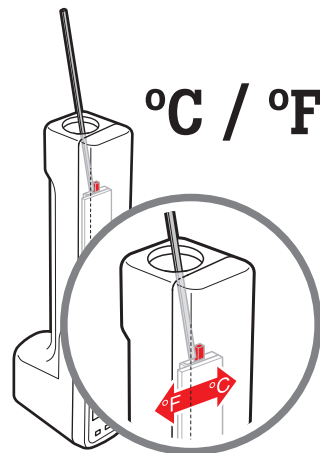
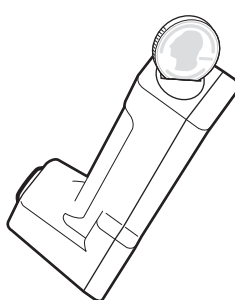
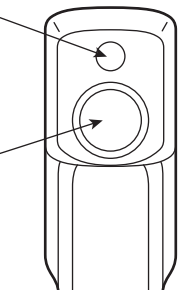

Battery Type
AA ANSI/NEDA
标准AA电池

