



EurotestEASI
MI 3100 SE, MI 3100 s
Instruction manual
Version 1.0, Code no. 20 752 165

Distributor:

Manufacturer:

METREL d.d.
Ljubljanska cesta 77
1354 Horjul
Slovenia
web site: <http://www.metrel.si>
e-mail: metrel@metrel.si



Mark on your equipment certifies that this equipment meets the requirements of the EU (European Union) concerning safety and electromagnetic compatibility regulations

© 2013 METREL

The trade names Metrel, Smartec, Eurotest, Autosequence are trademarks registered or pending in Europe and other countries.

No part of this publication may be reproduced or utilized in any form or by any means without permission in writing from METREL.

Table of contents

1	Preface	6
2	Safety and operational considerations	7
2.1	Warnings and notes	7
2.2	Battery and charging	11
2.3	Standards applied	13
3	Instrument description	15
3.1	Front panel	15
3.2	Connector panel	16
3.3	Back side.....	17
3.4	Carrying the instrument	18
3.4.1	Secure attachment of the strap	19
3.5	Instrument set and accessories.....	20
3.5.1	Standard set MI 3100 S – EurotestEASI	20
3.5.2	Standard set MI 3100 SE – EurotestEASI.....	20
3.5.3	Optional accessories	20
4	Instrument operation	21
4.1	Display and sound	21
4.1.1	Terminal voltage monitor.....	21
4.1.2	Battery indication.....	21
4.1.3	Messages.....	21
4.1.4	Results	22
4.1.5	Sound warnings	22
4.1.6	Help screens	22
4.1.7	Backlight and contrast adjustments.....	23
4.2	Function selection	23
4.3	Settings	25
4.3.1	Memory (MI 3100 SE only).....	25
4.3.2	Language	25
4.3.3	Date and time.....	26
4.3.4	RCD testing.....	26
4.3.5	Z factor	28
4.3.6	Commander support (MI 3100 SE only).....	28
4.3.7	Communication (MI 3100 SE only).....	29
4.3.8	Initial settings	31
5	Measurements	33
5.1	Voltage, frequency and phase sequence	33
5.2	Insulation resistance.....	35
5.3	Resistance of earth connection and equipotential bonding	37
5.3.1	Continuous resistance measurement.....	38
5.3.2	R LOW Ω , 200 mA resistance measurement	39
5.3.3	Continuous resistance measurement with low current	40
5.3.4	Compensation of test leads resistance.....	42
5.4	Ring continuity (only with EASI switch A 1214)	43
5.5	Testing RCDs	46

5.5.1	Contact voltage (RCD U_c).....	47
5.5.2	Trip-out time (RCDt).....	48
5.5.3	Trip-out current (RCD I).....	48
5.5.4	RCD Autotest.....	50
5.6	Fault loop impedance and prospective fault current.....	52
5.7	Line impedance and prospective short-circuit current / Voltage drop.....	54
5.7.1	Line impedance and prospective short circuit current.....	55
5.7.2	Voltage drop.....	56
5.8	Earth resistance.....	58
5.8.1	Standard earthing resistance measurement.....	59
5.9	PE test terminal.....	61
5.10	PE conductor resistance (MI 3100 SE only).....	63
6	Auto-sequences (MI 3100 SE only).....	65
7	Data handling (MI 3100 SE only).....	70
7.1	Memory organization.....	70
7.2	Data structure.....	70
7.3	Storing test results.....	72
7.4	Recalling test results.....	73
7.5	Clearing stored data.....	74
7.5.1	Clearing complete memory content.....	74
7.5.2	Clearing measurement(s) in selected location.....	74
7.5.3	Clearing individual measurements.....	75
7.5.4	Renaming installation structure elements (upload from PC).....	76
7.5.5	Renaming installation structure elements with serial barcode reader or RFID reader.....	76
7.6	Communication.....	77
7.6.1	USB and RS232 communication.....	77
7.6.2	Bluetooth communication.....	77
8	Upgrading the instrument.....	79
9	Maintenance.....	80
9.1	Fuse replacement.....	80
9.2	Cleaning.....	80
9.3	Periodic calibration.....	80
9.4	Service.....	80
10	Technical specifications.....	81
10.1	Insulation resistance.....	81
10.2	Continuity.....	82
10.2.1	Resistance R LOW, R2, R1+R2.....	82
10.2.2	Resistance CONTINUITY.....	82
10.2.3	RING Continuity.....	82
10.3	RCD testing.....	83
10.3.1	General data.....	83
10.3.2	Contact voltage RCD U_c	83
10.3.3	Trip-out time.....	84
10.3.4	Trip-out current.....	84
10.4	Fault loop impedance and prospective fault current.....	85
10.4.1	No disconnecting device or FUSE selected.....	85

10.4.2	RCD selected	85
10.5	Line impedance and prospective short-circuit current / Voltage drop	86
10.6	PE conductor resistance (MI 3100 SE only)	87
10.6.1	No RCD selected.....	87
10.6.2	RCD selected.....	87
10.7	Resistance to earth	88
10.7.1	Standard earthing resistance measurement – 3-wire measurement	88
10.8	Voltage, frequency, and phase rotation	89
10.8.1	Phase rotation	89
10.8.2	Voltage	89
10.8.3	Frequency	89
10.8.4	Online terminal voltage monitor.....	89
10.9	General data.....	90
Appendix A – Fuse table		91
A.2	Fuse table – impedances (UK)	91
Appendix B – Accessories for specific measurements		93
Appendix C – Commander (A 1401).....		94
C.1	 Warnings related to safety	94
C.2	Battery	94
C.3	Description of commanders.....	94
C.4	Operation of commander.....	95

1 Preface

Congratulations on your purchase of the Eurotest instrument and its accessories from METREL. The instrument was designed on a basis of rich experience, acquired through many years of dealing with electric installation test equipment.

The Eurotest instrument is a professional, multifunctional, hand-held test instrument intended to perform all the measurements on a.c. electrical LV installations.

The following measurements and tests can be performed:

- Voltage and frequency,
- Continuity tests,
- Insulation resistance tests,
- RCD testing,
- Fault loop / RCD trip-lock impedance measurements,
- Line impedance / Voltage drop,
- Phase sequence,
- Earthing resistance tests,
- Pre-defined auto-sequences (MI3100 SE only).

The graphic display with backlight offers easy reading of results, indications, measurement parameters and messages. Two LED PASS/FAIL indicators are placed at the sides of the LCD.

The operation of the instrument is designed to be as simple and clear as possible and no special training (except for the reading this instruction manual) is required in order to begin using the instrument.

In order for operator to be familiar enough with performing measurements in general and their typical applications it is advisable to read METREL handbook ***Guide for testing and verification of low voltage installations***.

The instrument is equipped with the entire necessary accessory for comfortable testing.

2 Safety and operational considerations

2.1 Warnings and notes

In order to maintain the highest level of operator safety while carrying out various tests and measurements, METREL recommends keeping your Eurotest instruments in good condition and undamaged. When using the instrument, consider the following general warnings:



General warnings related to safety:

- ❑ The  symbol on the instrument means »Read the Instruction manual with special care for safe operation«. The symbol requires an action!
- ❑ If the test equipment is used in a manner not specified in this user manual, the protection provided by the equipment could be impaired!
- ❑ Read this user manual carefully, otherwise the use of the instrument may be dangerous for the operator, the instrument or for the equipment under test!
- ❑ Do not use the instrument or any of the accessories if any damage is noticed!
- ❑ Consider all generally known precautions in order to avoid risk of electric shock while dealing with hazardous voltages!
- ❑ In case a fuse has blown follow the instructions in this manual in order to replace it! Use only fuses that are specified!
- ❑ Do not use the instrument in AC supply systems with voltages higher than 550 Va.c.
- ❑ Service, repairs or adjustment of instruments and accessories is only allowed to be carried out by a competent authorized personnel!
- ❑ Use only standard or optional test accessories supplied by your distributor!
- ❑ Consider that protection category of some accessories is lower than of the instrument. Test tips and Tip commander have removable caps. If they are removed the protection falls to CAT II. Check markings on accessories!
 - cap off, 18 mm tip: CAT II up to 1000 V
 - cap on, 4 mm tip: CAT II 1000 V / CAT III 600 V / CAT IV 300 V
- ❑ The instrument comes supplied with rechargeable Ni-MH battery cells. The cells should only be replaced with the same type as defined on the battery compartment label or as described in this manual. Do not use standard alkaline battery cells while the power supply adapter is connected, otherwise they may explode!

- ❑ Hazardous voltages exist inside the instrument. Disconnect all test leads, remove the power supply cable and switch off the instrument before removing battery compartment cover.
- ❑ Do not connect any voltage source on C1 input. It is intended only for connection of current clamps. Maximal input voltage is 3 V!
- ❑ All normal safety precautions must be taken in order to avoid risk of electric shock while working on electrical installations!



Warnings related to safety of measurement functions:

Insulation resistance

- ❑ Insulation resistance measurement should only be performed on de-energized objects!
- ❑ Do not touch the test object during the measurement or before it is fully discharged! Risk of electric shock!
- ❑ When an insulation resistance measurement has been performed on a capacitive object, automatic discharge may not be done immediately! The warning message  and the actual voltage are displayed during discharge until voltage drops below 30 V.
- ❑ Do not connect test terminals to external voltage higher than 600 V (AC or DC) in order not to damage the test instrument!

Continuity functions

- ❑ Continuity measurements should only be performed on de-energized objects!
- ❑ Parallel loops may influence on test results.

Testing PE terminal

- ❑ If phase voltage is detected on the tested PE terminal, stop all measurements immediately and ensure the cause of the fault is eliminated before proceeding with any activity!

Notes related to measurement functions:

General

- ❑ The  indicator means that the selected measurement cannot be performed because of irregular conditions on input terminals.
- ❑ Insulation resistance, continuity functions and earth resistance measurements can only be performed on de-energized objects.
- ❑ PASS / FAIL indication is enabled when limit is set. Apply appropriate limit value for evaluation of measurement results.
- ❑ In the case that only two of the three wires are connected to the electrical installation under test, only voltage indication between these two wires is valid.

Insulation resistance

- The standard three-wire test lead, plug test cable or Plug / Tip commanders can be used for the insulation test with voltages $\leq 1\text{kV}$.
- If a voltage of higher than 30 V (AC or DC) is detected between test terminals, the insulation resistance measurement will not be performed.
- The instrument automatically discharge tested object after finished measurement.
- A double click of TEST key starts a continuous measurement.

Continuity functions

- If a voltage of higher than 10 V (AC or DC) is detected between test terminals, the continuity resistance test will not be performed.
- Compensate test lead resistance before performing a continuity measurement, where necessary.

Earth resistance

- If voltage between test terminals is higher than 30 V the resistance to earth measurement will not be performed.
- If a noise voltage higher than approx. 5 V is present between the H and E or S test terminals, “” (noise) warning symbol will be displayed, indicating that the test result may not be correct!

RCD functions

- Parameters set in one function are also kept for other RCD functions!
- The measurement of contact voltage does not normally trip an RCD. However, the trip limit of the RCD may be exceeded as a result of leakage current flowing to the PE protective conductor or a capacitive connection between L and PE conductors.
- The RCD trip-lock sub-function (function selector switch in LOOP position) takes longer to complete but offers much better accuracy of fault loop resistance (in comparison to the R_L sub-result in Contact voltage function).
- RCD trip-out time and RCD trip-out current measurements will only be performed if the contact voltage in the pre-test at nominal differential current is lower than the set contact voltage limit!
- The autotest sequence (RCD AUTO function) stops when trip-out time is out of allowable time period.

Z-LOOP

- The low limit prospective short-circuit current value depends on fuse type, fuse current rating, fuse trip-out time and impedance scaling factor.
- The specified accuracy of tested parameters is valid only if the mains voltage is stable during the measurement.
- Fault loop impedance measurements will trip an RCD.
- The measurement of fault loop impedance using trip-lock function does not normally trip an RCD. However, the trip limit may be exceeded if a leakage current flows to the PE protective conductor or if there is a capacitive connection between L and PE conductors.

Z-LINE / Voltage drop

- In case of measurement of $Z_{\text{Line-Line}}$ with the instrument test leads PE and N connected together the instrument will display a warning of dangerous PE voltage. The measurement will be performed anyway.
- Specified accuracy of tested parameters is valid only if mains voltage is stable during the measurement.

Testing PE terminal

- PE terminal can be tested in RCD, LOOP and LINE function selector switch positions only!
- For correct testing of PE terminal, the TEST key has to be touched for a few seconds.
- Make sure to stand on non-isolated floor while carrying out the test, otherwise test result may be wrong!

PE conductor resistance (MI 3100 SE)

- The specified accuracy of tested parameters is valid only if the mains voltage is stable during the measurement.
- PE conductor resistance measurement will trip an RCD.
- The measurement of PE conductor resistance using trip-lock function does not normally trip an RCD. However, the trip limit may be exceeded if a leakage current flows to the PE protective conductor or if there is a capacitive connection between L and PE conductors.

Autosequence tests (MI 3100 SE)

See notes above for selected tests in Autosequence.

2.2 Battery and charging

The instrument uses six AA size alkaline or rechargeable Ni-MH battery cells. Nominal operating time is declared for cells with nominal capacity of 2100 mAh. Battery condition is always displayed in the lower right display part. In case the battery is too weak the instrument indicates this as shown in figure 2.1. This indication appears for a few seconds and then the instrument turns itself off.

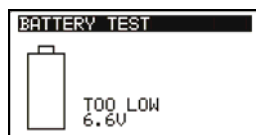

Figure 2.1: Discharged battery indication

The battery is charged whenever the power supply adapter is connected to the instrument. The power supply socket polarity is shown in figure 2.2. Internal circuit controls charging and assures maximum battery lifetime.



Figure 2.2: Power supply socket polarity

Symbols:

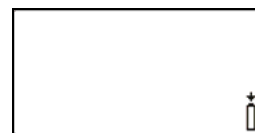
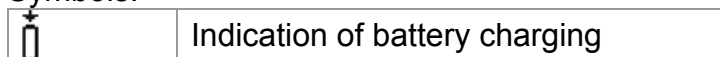

Figure 2.3: Charging indication



Warnings related to safety:

- ❑ When connected to an installation, the instruments battery compartment can contain hazardous voltage inside! When replacing battery cells or before opening the battery/fuse compartment cover, disconnect any measuring accessory connected to the instrument and turn off the instrument,
- ❑ Ensure that the battery cells are inserted correctly otherwise the instrument will not operate and the batteries could be discharged.
- ❑ Do not recharge alkaline battery cells!
- ❑ Use only power supply adapter delivered from the manufacturer or distributor of the test equipment !

Notes:

- ❑ The charger in the instrument is a pack cell charger. This means that the battery cells are connected in series during the charging. The battery cells have to be equivalent (same charge condition, same type and age).
- ❑ If the instrument is not to be used for a long period of time, remove all batteries from the battery compartment.
- ❑ Alkaline or rechargeable Ni-MH batteries (size AA) can be used. METREL recommends only using rechargeable batteries with a capacity of 2100mAh or above.

- Unpredictable chemical processes can occur during the charging of battery cells that have been left unused for a longer period (more than 6 months). In this case METREL recommends to repeat the charge / discharge cycle at least 2-4 times.
- If no improvement is achieved after several charge / discharge cycles, then each battery cell should be checked (by comparing battery voltages, testing them in a cell charger, etc). It is very likely that only some of the battery cells are deteriorated. One different battery cell can cause an improper behaviour of the entire battery pack!
- The effects described above should not be confused with the normal decrease of battery capacity over time. Battery also loses some capacity when it is repeatedly charged / discharged. This information is provided in the technical specification from battery manufacturer.

2.3 Standards applied

The Eurotest instruments are manufactured and tested in accordance with the following regulations:

Electromagnetic compatibility (EMC)

BS EN 61326	Electrical equipment for measurement, control and laboratory use – EMC requirements Class B (Hand-held equipment used in controlled EM environments)
-------------	---

Safety (LVD)

BS EN 61010-1	Safety requirements for electrical equipment for measurement, control and laboratory use – Part 1: General requirements
BS EN 61010-2-030	Safety requirements for electrical equipment for measurement, control and laboratory use – Part 2-030: Particular requirements for testing and measuring circuits
BS EN 61010-031	Safety requirements for electrical equipment for measurement, control and laboratory use – Part 031: Safety requirements for hand-held probe assemblies for electrical measurement and test
BS EN 61010-2-032	Safety requirements for electrical equipment for measurement, control, and laboratory use - Part 2-032: Particular requirements for hand-held and hand-manipulated current sensors for electrical test and measurement

Functionality

BS EN 61557	Electrical safety in low voltage distribution systems up to 1000 V _{AC} and 1500 V _{AC} – Equipment for testing, measuring or monitoring of protective measures Part 1: General requirements Part 2: Insulation resistance Part 3: Loop resistance Part 4: Resistance of earth connection and equipotential bonding Part 5: Resistance to earth Part 6: Residual current devices (RCDs) in TT and TN systems Part 7: Phase sequence Part 10: Combined measuring equipment Part 12: Performance measuring and monitoring devices (PMD)
-------------	--

Reference standards for electrical installations and components

BS EN 61008	Residual current operated circuit-breakers without integral overcurrent protection for household and similar uses
BS EN 61009	Residual current operated circuit-breakers with integral overcurrent protection for household and similar uses
IEC 60364-4-41	Electrical installations of buildings Part 4-41 Protection for safety – protection against electric shock
BS 7671	IEE Wiring Regulations (17 th edition)
AS/NZS 3017	Electrical installations – Verification guidelines

Note about EN and IEC standards:

- Text of this manual contains references to European standards. All standards of EN 6XXXX (e.g. EN 61010) series are equivalent to IEC standards with the same number (e.g. IEC 61010) and differ only in amended parts required by European harmonization procedure.

3 Instrument description

3.1 Front panel

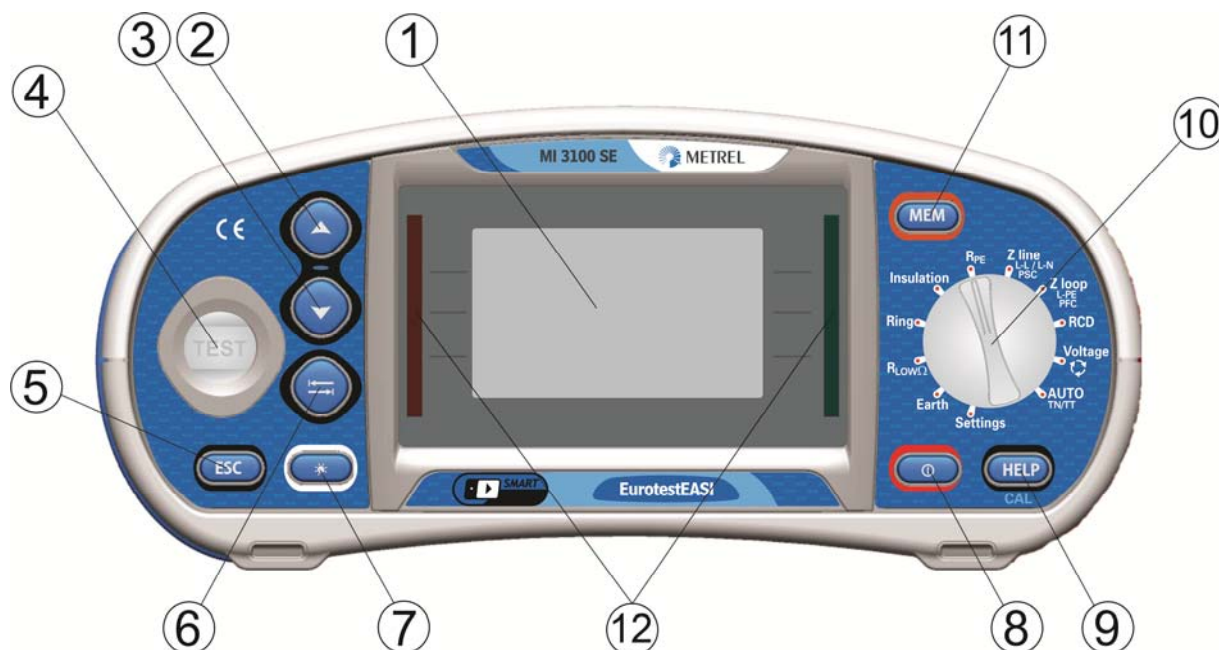

Figure 3.1: Front panel

Legend:

1	LCD	128 x 64 dots matrix display with backlight.
2	UP	Modifies selected parameter.
3	DOWN	
4	TEST	TEST Starts measurements. Acts also as the PE touching electrode.
5	ESC	Goes one level back.
6	TAB	Selects the parameters in selected function.
7	Backlight, Contrast	Changes backlight level and contrast.
8	ON / OFF	Switches the instrument power on or off. The instrument automatically turns off 15 minutes after the last key was pressed.
9	HELP / CAL	Accesses help menus. Calibrates test leads in Continuity functions. Starts Z_{REF} measurement in Voltage drop sub-function.
10	Function selector switch	Selects test / measurement function and settings.
11	MEM	Stores / recalls memory of instrument (MI 3100 SE only). No function (MI 3100 S).
12	Green LEDs Red LEDs	Indicates PASS / FAIL of result.

3.2 Connector panel

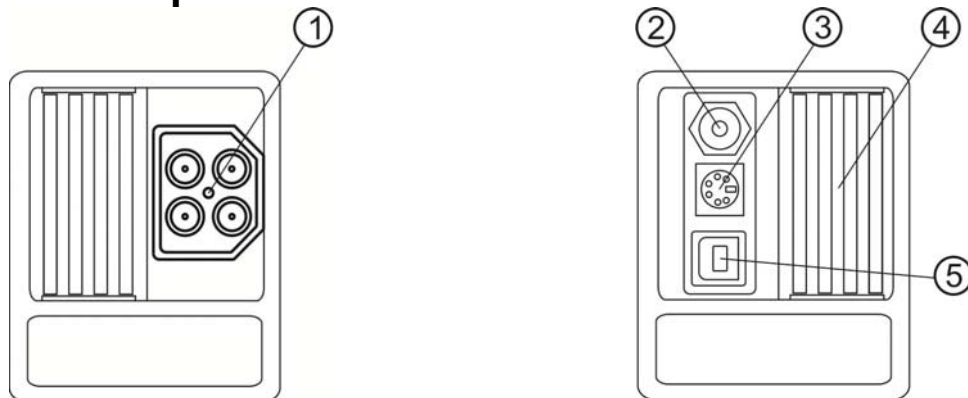

Figure 3.2: Connector panel

Legend:

1	Test connector	Measuring inputs / outputs.
2	Charger socket	
3	PS/2 connector (MI 3100 SE)	Communication with PC serial port Connection to barcode / RFID reader Connection of Bluetooth dongle
4	Protection cover	
5	USB connector (MI 3100 SE)	Communication with PC USB (1.1) port.



Warnings!

- ❑ Maximum allowed voltage between any test terminal and ground is 600 V!
- ❑ Maximum allowed voltage between test terminals on test connector is 600 V!
- ❑ Maximum short-term voltage of external power supply adapter is 14 V!

3.3 Back side

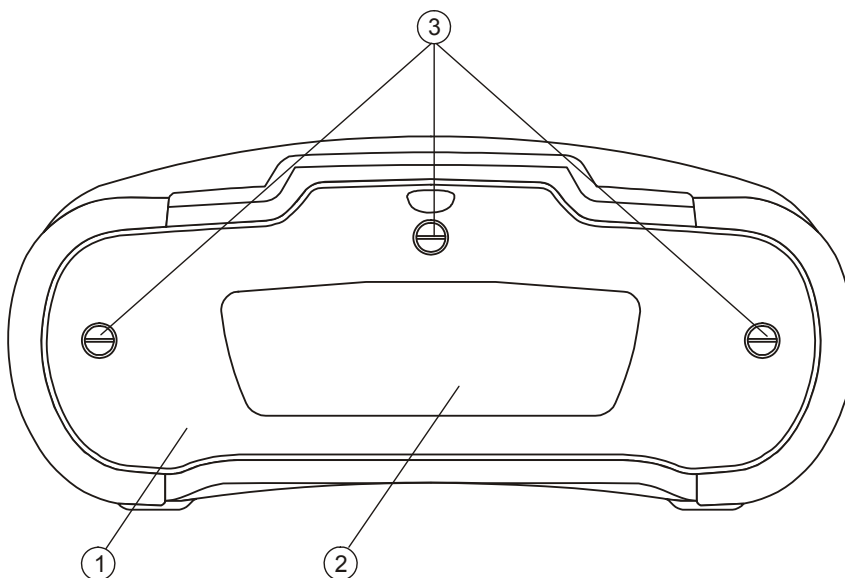

Figure 3.3: Back panel

Legend:

1	Battery / fuse compartment cover
2	Back panel information label
3	Fixing screws for battery / fuse compartment cover

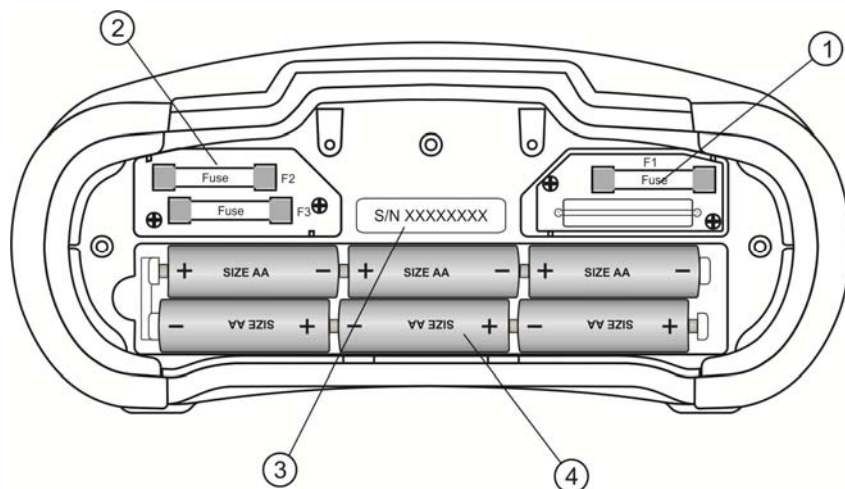

Figure 3.4: Battery and fuse compartment

Legend:

1	Fuse F1	M 315 mA / 250 V
2	Fuses F2 and F3	F 4 A / 500 V (breaking capacity 50 kA)
3	Serial number label	
4	Battery cells	Size AA, alkaline / rechargeable NiMH

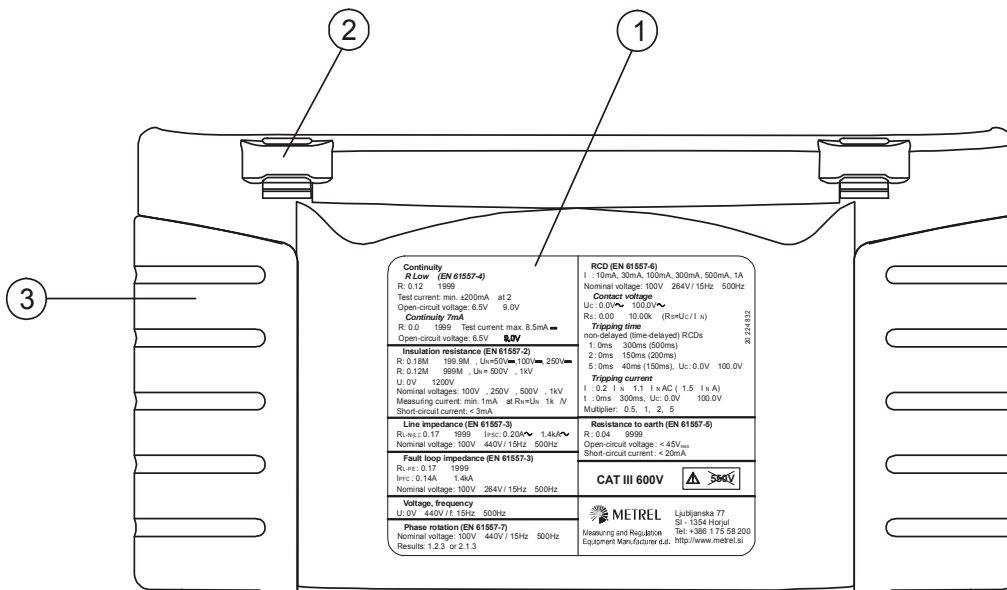

Figure 3.5: Bottom

Legend:

- 1 Bottom information label
- 2 Neck belt openings
- 3 Handling side covers

3.4 Carrying the instrument

With the neck-carrying belt supplied in standard set, various possibilities of carrying the instrument are available. Operator can choose appropriate one on basis of his operation, see the following examples:



The instrument hangs around operators neck only – quick placing and displacing.



The instrument can be used even when placed in soft carrying bag – test cable connected to the instrument through the front aperture.

3.4.1 Secure attachment of the strap

You can choose between two methods:

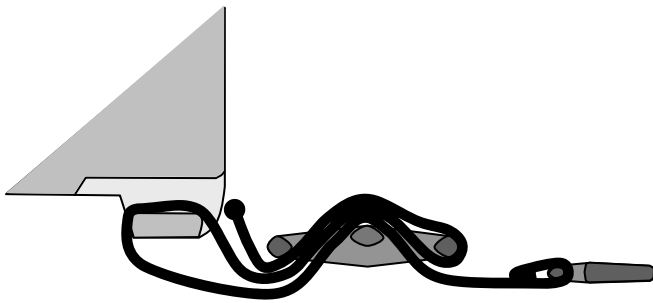

Figure 3.6: First method

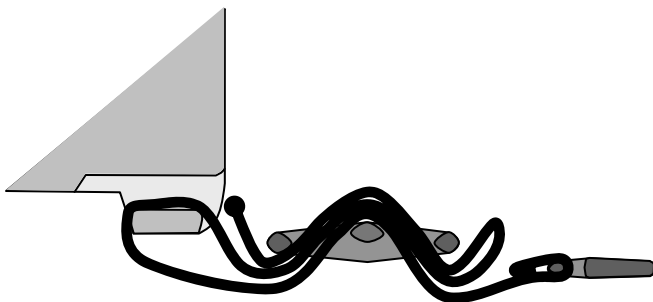

Figure 3.7: Alternative method

Please perform a periodical check of the attachment.

3.5 Instrument set and accessories

3.5.1 Standard set MI 3100 S – EurotestEASI

- Instrument
- Soft carrying bag
- Plug test cable
- Test lead, 3 x 1.5 m
- Test probe, 3 pcs
- Crocodile clip, 3 pcs
- Set of carrying straps
- Set of Ni-MH battery cells
- Power supply adapter
- CD with instruction manual, and “Guide for testing and verification of low voltage installations” handbook.
- Short instruction manual
- Calibration Certificate

3.5.2 Standard set MI 3100 SE – EurotestEASI

- Instrument
- Soft carrying bag
- Plug test cable
- Test lead, 3 x 1.5 m
- Test probe, 3 pcs
- Crocodile clip, 3 pcs
- Set of carrying straps
- RS232-PS/2 cable
- USB cable
- Set of Ni-MH battery cells
- Power supply adapter
- CD with instruction manual, and “Guide for testing and verification of low voltage installations” handbook and PC software EuroLinkPRO.
- Short instruction manual
- Calibration Certificate

3.5.3 Optional accessories

See the attached sheet for a list of optional accessories that are available on request from your distributor.

4 Instrument operation

4.1 Display and sound

4.1.1 Terminal voltage monitor

The terminal voltage monitor displays on-line the voltages on the test terminals and information about active test terminals in the a.c. installation measuring mode.



Online voltages are displayed together with test terminal indication. All three test terminals are used for selected measurement.

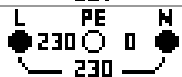

Online voltages are displayed together with test terminal indication. L and N test terminals are used for selected measurement.

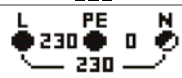

L and PE are active test terminals; N terminal should also be connected for correct input voltage condition.

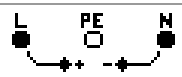

Polarity of test voltage applied to the output terminals, L and N.

4.1.2 Battery indication

The battery indication indicates the charge condition of battery and connection of external charger.



Battery capacity indication.



Low battery.

Battery is too weak to guarantee correct result. Replace or recharge the battery cells.



Charging in progress (if power supply adapter is connected).

4.1.3 Messages

In the message field warnings and messages are displayed.



Measurement is running, consider displayed warnings.



Conditions on the input terminals allow starting the measurement; consider other displayed warnings and messages.



Conditions on the input terminals do not allow starting the measurement, consider displayed warnings and messages.



RCD tripped-out during the measurement (in RCD functions).











Portable RCD selected (PRCD).





Instrument is overheated. The measurement is prohibited until the temperature decreases under the allowed limit.



Result(s) can be stored. (MI 3100 SE only)

	High electrical noise was detected during measurement. Results may be impaired.
	L and N are changed.
	Warning! High voltage is applied to the test terminals.
	Warning! Dangerous voltage on the PE terminal! Stop the activity immediately and eliminate the fault / connection problem before proceeding with any activity!
	Test leads resistance in Continuity measurement is not compensated.
	Test leads resistance in Continuity measurement is compensated.
	High resistance to earth of test probes. Results may be impaired.
	Measured signal is out of range (clipped). Results are impaired.
	Fuse F1 is broken.

4.1.4 Results

	Measurement result is inside pre-set limits (PASS).
	Measurement result is out of pre-set limits (FAIL).
	Measurement is aborted. Consider displayed warnings and messages.

4.1.5 Sound warnings

Continuous sound **Warning!** Dangerous voltage on the PE terminal is detected.

4.1.6 Help screens

HELP	Opens help screen.
-------------	--------------------

Help menus are available in all functions. The Help menu contains schematic diagrams for illustrating how to properly connect the instrument to electric installation. After selecting the measurement you want to perform, press the HELP key in order to view the associated Help menu.

Keys in help menu:

UP / DOWN	Selects next / previous help screen.
ESC / HELP / Function selector switch	Exits help menu.



Figure 4.1: Examples of help screens

4.1.7 Backlight and contrast adjustments

With the BACKLIGHT key backlight and contrast can be adjusted.

Click	Toggles backlight intensity level.
Keep pressed for 1 s	Locks high intensity backlight level until power is turned off or the key is pressed again.
Keep pressed for 2 s	Bargraph for LCD contrast adjustment is displayed.

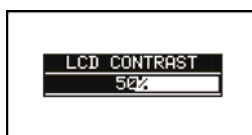

Figure 4.2: Contrast adjustment menu

Keys for contrast adjustment:

DOWN	Reduces contrast.
UP	Increases contrast.
TEST	Accepts new contrast.
ESC	Exits without changes.

4.2 Function selection

For selecting test/measurement function, entering settings menu and auto-test mode (MI 3100 SE only) the **FUNCTION SELECTOR SWITCH** shall be used.

Function selector switch and keys:

Function selector switch	Selects test / measurement function enters settings menu and selects auto-test mode.
UP / DOWN	Selects sub-function in selected measurement function.
TAB	Selects the test parameter to be set or modified.
TEST	Runs selected test / measurement function.
MEM	Stores measured results / recalls stored results. (MI 3100 SE only)
ESC	Exits back to main menu.

Keys in **test parameter** field:

UP / DOWN	Changes the selected parameter.
TAB	Selects the next measuring parameter.
Function selector switch	Toggles between the main functions.
MEM	Stores measured results / recalls stored results. (MI 3100 SE only)

General rule regarding enabling **parameters** for evaluation of measurement / test result:

Parameter	OFF	No limit values, indication: _ _ _.
	ON	Value(s) – results will be marked as PASS or FAIL in accordance with selected limit.

See chapter **5 Measurements** for more information about the operation of the instrument test functions.

4.3 Settings

Different instrument options can be set in the SETTINGS menu.

Options are:

- recalling and clearing stored results (MI 3100 SE only),
- selection of language,
- setting the date and time,
- selection of reference standard for RCD tests,
- entering Z factor,
- commander support (MI 3100 SE only),
- settings for bluetooth communication (MI 3100 SE only),
- setting the instrument to initial values.

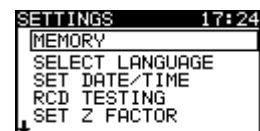

Figure 4.3: Options in Settings menu

Keys:

UP / DOWN	Selects appropriate option.
TEST	Enters selected option.
Function selector switch	Exits back to selected test / measurement function without changes.

4.3.1 Memory (MI 3100 SE only)

In this menu the stored data can be recalled or deleted. See chapter 7 **Data handling** for more information.

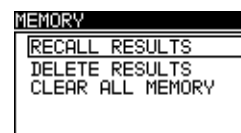

Figure 4.4: Memory options

Keys:

UP / DOWN	Selects option.
TEST	Enters selected option.
ESC	Exits back to settings menu.
Function selector switch	Exits back to selected test / measurement function without changes.

4.3.2 Language

In this menu the language can be set.



Figure 4.5: Language selection

Keys:

UP / DOWN	Selects language.
TEST	Confirms selected language and exits to settings menu.
ESC	Exits back to settings menu.
Function selector switch	Exits back to selected test / measurement function without changes.

4.3.3 Date and time

In this menu date and time can be set.

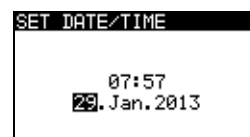

Figure 4.6: Setting date and time

Keys:

TAB	Selects the field to be changed.
UP / DOWN	Modifies selected field.
TEST	Confirms new date / time and exits.
ESC	Exits back to settings menu.
Function selector switch	Exits back to selected test / measurement function without changes.

Note:

- If the batteries are removed for more than 1 minute the set date and time will be lost.

4.3.4 RCD testing

In this menu the used standard for RCD tests can be set.

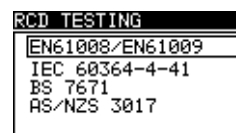

Figure 4.7: Selection of RCD test standard

Keys:

UP / DOWN	Selects standard.
TEST	Confirms selected standard.
ESC	Exits back to settings menu.
Function selector switch	Exits back to selected test / measurement function without changes.

Maximum RCD disconnection times differ in various standards.
The trip-out times defined in individual standards are listed below.

Trip-out times according to EN 61008 / EN 61009:

$\frac{1}{2} \times I_{\Delta N}^*)$	$I_{\Delta N}$	$2 \times I_{\Delta N}$	$5 \times I_{\Delta N}$
--------------------------------------	----------------	-------------------------	-------------------------

General RCDs (non-delayed)	$t_{\Delta} > 300$ ms	$t_{\Delta} < 300$ ms	$t_{\Delta} < 150$ ms	$t_{\Delta} < 40$ ms
Selective RCDs (time-delayed)	$t_{\Delta} > 500$ ms	$130 \text{ ms} < t_{\Delta} < 500$ ms	$60 \text{ ms} < t_{\Delta} < 200$ ms	$50 \text{ ms} < t_{\Delta} < 150$ ms

Trip-out times according to EN 60364-4-41:

	$\frac{1}{2} \times I_{\Delta N}^{*)}$	$I_{\Delta N}$	$2 \times I_{\Delta N}$	$5 \times I_{\Delta N}$
General RCDs (non-delayed)	$t_{\Delta} > 999$ ms	$t_{\Delta} < 999$ ms	$t_{\Delta} < 150$ ms	$t_{\Delta} < 40$ ms
Selective RCDs (time-delayed)	$t_{\Delta} > 999$ ms	$130 \text{ ms} < t_{\Delta} < 999$ ms	$60 \text{ ms} < t_{\Delta} < 200$ ms	$50 \text{ ms} < t_{\Delta} < 150$ ms

Trip-out times according to BS 7671:

	$\frac{1}{2} \times I_{\Delta N}^{*)}$	$I_{\Delta N}$	$2 \times I_{\Delta N}$	$5 \times I_{\Delta N}$
General RCDs (non-delayed)	$t_{\Delta} > 1999$ ms	$t_{\Delta} < 300$ ms	$t_{\Delta} < 150$ ms	$t_{\Delta} < 40$ ms
Selective RCDs (time-delayed)	$t_{\Delta} > 1999$ ms	$130 \text{ ms} < t_{\Delta} < 500$ ms	$60 \text{ ms} < t_{\Delta} < 200$ ms	$50 \text{ ms} < t_{\Delta} < 150$ ms

Trip-out times according to AS/NZS 3017^{**}):

	$\frac{1}{2} \times I_{\Delta N}^{*)}$	$I_{\Delta N}$	$2 \times I_{\Delta N}$	$5 \times I_{\Delta N}$		
RCD type	$I_{\Delta N}$ [mA]	t_{Δ}	t_{Δ}	t_{Δ}	t_{Δ}	Note
I	≤ 10	> 999 ms	40 ms	40 ms	40 ms	Maximum break time
II	$> 10 \leq 30$		300 ms	150 ms	40 ms	
III	> 30		300 ms	150 ms	40 ms	
IV \square	> 30	> 999 ms	500 ms	200 ms	150 ms	
			130 ms	60 ms	50 ms	

^{*)} Minimum test period for current of $\frac{1}{2} \times I_{\Delta N}$, RCD shall not trip-out.

^{**)} Test current and measurement accuracy correspond to AS/NZS 3017 requirements.

Maximum test times related to selected test current for general (non-delayed) RCD

Standard	$\frac{1}{2} \times I_{\Delta N}$	$I_{\Delta N}$	$2 \times I_{\Delta N}$	$5 \times I_{\Delta N}$
EN 61008 / EN 61009	300 ms	300 ms	150 ms	40 ms
EN 60364-4-41	1000 ms	1000 ms	150 ms	40 ms
BS 7671	2000 ms	300 ms	150 ms	40 ms
AS/NZS 3017 (I, II, III)	1000 ms	1000 ms	150 ms	40 ms

Maximum test times related to selected test current for selective (time-delayed) RCD

Standard	$\frac{1}{2} \times I_{\Delta N}$	$I_{\Delta N}$	$2 \times I_{\Delta N}$	$5 \times I_{\Delta N}$
----------	-----------------------------------	----------------	-------------------------	-------------------------

EN 61008 / EN 61009	500 ms	500 ms	200 ms	150 ms
EN 60364-4-41	1000 ms	1000 ms	200 ms	150 ms
BS 7671	2000 ms	500 ms	200 ms	150 ms
AS/NZS 3017 (IV)	1000 ms	1000 ms	200 ms	150 ms

Note:

- Trip-out limit times for PRCD, PRCD-K and PRCD-S are equal to General (non-delayed) RCDs.

4.3.5 Z factor

In this menu the Z factor can be set.

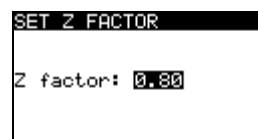

Figure 4.8: Selection of Z factor

Keys:

UP / DOWN	Sets Z value.
TEST	Confirms Z value.
ESC	Exits back to settings menu.
Function selector switch	Exits back to selected test / measurement function without changes.

The impedance limit values for different overcurrent protective devices are scaled down by a factor 0,8 or 0,75 (Z factor). This means that the fault current will still be high enough also at increased conductor temperatures and low supply voltage. This assures a safe operation of the overcurrent protection device in all conditions.

4.3.6 Commander support (MI 3100 SE only)

The support for remote commanders can be enabled or disabled in this menu.



Figure 4.9: Selection of commander support

Keys:

UP / DOWN	Selects commander option.
TEST	Confirms selected option.
ESC	Exits back to settings menu.
Function selector switch	Exits back to selected test / measurement function without changes.

Note:

- Commander disabled option is intended to disable the commander's remote keys. In the case of high EM interfering noise the operation of the commander can be irregular.

4.3.7 Communication (MI 3100 SE only)

In this menu the Bluetooth dongle A1436 can be initialized and device for scanning barcodes can be selected.

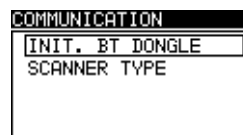

Figure 4.10: Menu for bluetooth communication

Keys:

UP / DOWN	Selects option.
TEST	Confirms selected option.
ESC	Exits back to settings menu.
Function selector switch	Exits back to selected test / measurement function without changes.

Initialization of the Bluetooth dongle

The Bluetooth dongle A1436 should be initialized when it is used with the instrument for the first time. During initialization the instrument sets the dongle parameters and name in order to communicate properly with PC and other devices via Bluetooth.

Initialization procedure

- Connect Bluetooth dongle A1436 to the instrument.
- Press **RESET** key on the Bluetooth dongle A1436 for **at least 10 seconds**.
- Select **INIT. BT DONGLE** in **Communication menu** and press the **TEST** key.
- Wait for confirmation message and beep. Following message is displayed if dongle was initialized properly: **EXTERNAL BT DONGLE SEARCHING OK!**

Notes:

- The Bluetooth dongle A1436 should always be initialized before first use with the instrument.
- If the dongle was initialized by an another Metrel instrument it will probably not work properly when working with the instrument again.
- For more information about communication via Bluetooth refer to chapter 7.6 *Communication* and A1436 manual.

Selection of barcode scanner type

In this menu the barcode scanner type can be set. Options are:

- ❑ serial barcode scanner and
- ❑ barcode scanner application on Android devices.

Keys:

UP / DOWN	Selects option.
TEST	Confirms selected option.
ESC	Exits back to Communication menu.
Function selector	Exits back to selected test / measurement function without changes.

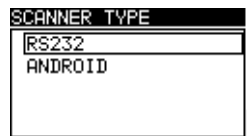

Figure 4.11: Menu for scanner type

4.3.8 Initial settings

In this menu the instrument settings, measurement parameters and limits can be set to initial (factory) values.



Figure 4.12: Initial settings dialogue

Keys:

UP / DOWN	Selects option [YES, NO].
TEST	Restores default settings (if YES is selected).
ESC	Exits back to settings menu.
Function selector switch	Exits back to selected test / measurement function without changes.



Warnings:

- ❑ Customized settings will be lost when this option is used!
- ❑ If the batteries are removed for more than 1 minute the custom made settings will be lost.

The default setup is listed below:

Instrument setting	Default value
Language	English
Contrast	As defined and stored by adjustment procedure
Z factor	0.80
RCD standards	BS 7671
Commander (MI 3100 SE only)	A 1314, A 1401
Scanner type (MI 3100 SE only)	RS 232

Test mode: Function Sub-function	Parameters / limit value
INSTALLATION:	
EARTH RE	No limit
R ISO	L / E No limit Utest = 500 V
Low Ohm Resistance R LOW Ω , r ₁ , r _n , r ₂ , R1+R2, R2, R1+RN, CONTINUITY	No limit No limit, sound OFF
Rpe (MI 3100 SE only) Rpe Rpe(rcd)	No limit No limit

Z - LINE VOLTAGE DROP	Fuse type: none selected ΔU : 4.0 % Z_{REF} : 0.00 Ω
Z - LOOP	Fuse type: none selected
Zs rcd	Fuse type: none selected
RCD	RCD t Nominal differential current: $I_{\Delta N}=30$ mA RCD type: AC, non-delayed Test current starting polarity:  (0°) Limit contact voltage: 50 V Current multiplier: $\times 1$
AUTO SEQUENCES (MI 3100 SE only):	
AUTO TT	FUSE: None selected Z_{REF} : --- ΔU : 4.0 % RCD: 30 mA, AC, non-delayed,  (0°) Uc: 50 V
AUTO TN (rcd)	FUSE: None selected Z_{REF} : --- ΔU : 4.0 % Rpe: No limit
AUTO TN	FUSE: None selected Z_{REF} : --- ΔU : 4.0 % Rpe: No limit

Note:

- Initial settings (reset of the instrument) can be recalled also if the TAB key is pressed while the instrument is switched on.

5 Measurements

5.1 Voltage, frequency and phase sequence

Voltage and frequency measurement is always active in the terminal voltage monitor. In the special **VOLTAGE TRMS** menu the measured voltage, frequency and information about detected three-phase connection can be stored. Measurements are based on the BS EN 61557-7 standard.

See chapter **4.2 Function selection** for instructions on key functionality.

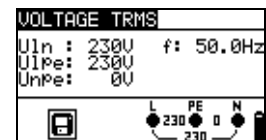

Figure 5.1: Voltage in single phase system

Test parameters for voltage measurement

There are no parameters to be set.

Connections for voltage measurement

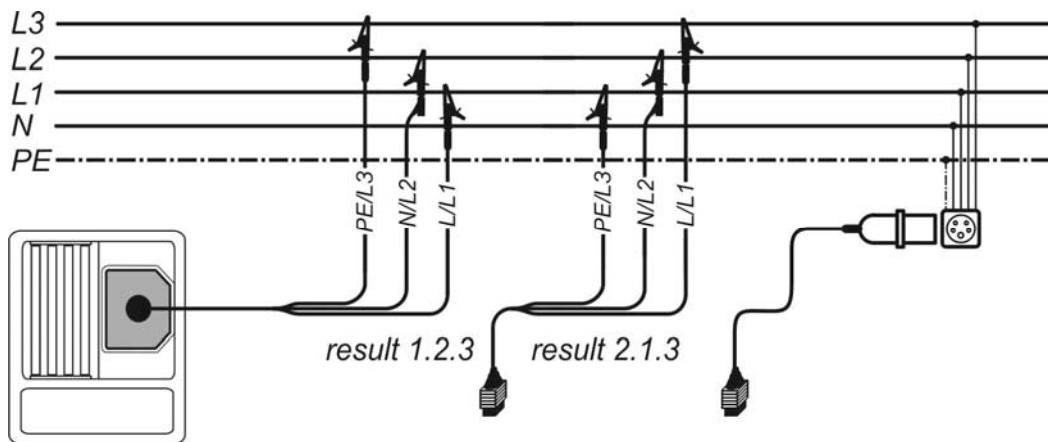

Figure 5.2: Connection of 3-wire test lead and optional adapter in three-phase system

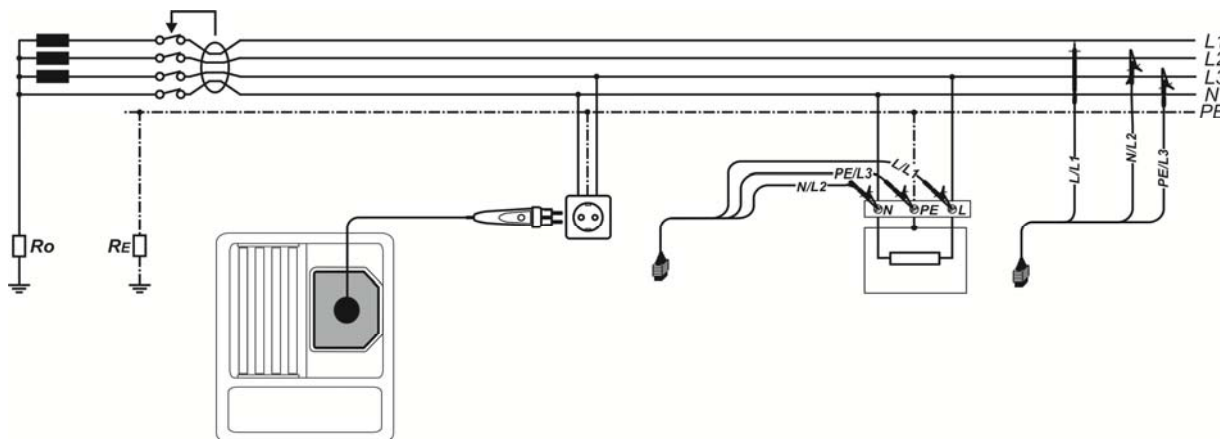

Figure 5.3: Connection of plug test cable and 3-wire test lead in single-phase system

Voltage measurement procedure

- ❑ Select the **VOLTAGE TRMS** function using the function selector switch.
- ❑ **Connect** test cable to the instrument.
- ❑ **Connect** test leads to the item to be tested (see Figure 5.2 and Figure 5.3).
- ❑ **Store** voltage measurement result by pressing the **MEM** key (MI 3100 SE only).

Measurement runs immediately after selection of **VOLTAGE TRMS** function.



Figure 5.4: Examples of voltage measurement in three-phase system

Displayed results for single phase system:

- Uln** voltage between phase and neutral conductors
- Uipe** voltage between phase and protective conductors
- Unpe** voltage between neutral and protective conductors
- f** frequency

Displayed results for three-phase system:

- U12** voltage between phases L1 and L2
- U13** voltage between phases L1 and L3
- U23** voltage between phases L2 and L3
- 1.2.3** correct connection – CW rotation sequence
- 3.2.1** invalid connection – CCW rotation sequence
- f** frequency

5.2 Insulation resistance

The insulation resistance measurement is performed in order to ensure safety against electric shock through insulation. Typical applications are:

- ❑ insulation resistance between conductors of installation,
- ❑ insulation resistance of non-conductive rooms (walls and floors),
- ❑ insulation resistance of ground cables and
- ❑ resistance of semi-conductive (antistatic) floors.

Four insulation resistance sub-functions are available:

- ISO L/E,
- ISO L/N,
- ISO L/L and
- ISO N/E.

The insulation resistance tests are carried out in the same way regardless which sub-function is selected. However it is important to select the appropriate sub-function in order to classify the measurement to be correctly considered in verification documents (Electrical Installation Certificate, Periodic Inspection Report etc.).

See chapter 4.2 **Function selection** for instructions on key functionality.



Figure 5.5: Insulation resistance

Test parameters for insulation resistance measurement

Test	Sub-function [ISO L/E, ISO L/N, ISO L/L, ISO N/E]
Uiso	Nominal test voltage [50 V, 100 V, 250 V, 500 V, 1000 V]
Limit	Minimum insulation resistance [OFF, 0.01 MΩ ÷ 200 MΩ]

Test circuits for insulation resistance

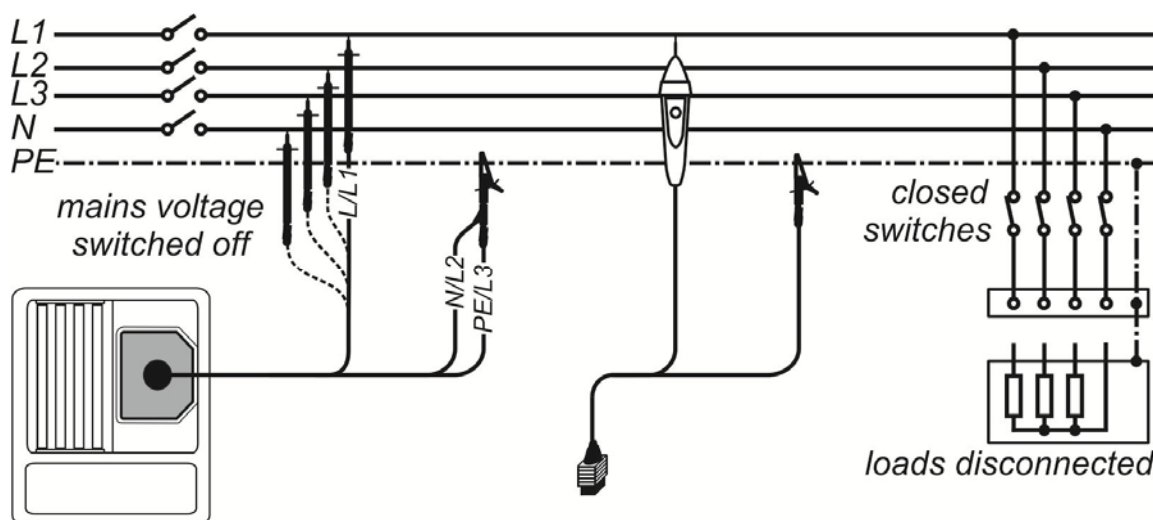

Figure 5.6: Connection of 3-wire test lead and tip commander

Insulation resistance measuring procedure

- ❑ Select the **R ISO** function using the function selector switch.
- ❑ Set sub-function to **ISO L/E**, **ISO L/N**, **ISO L/L**, or **ISO N/E** using **UP / DOWN** keys.
- ❑ Set the required **test voltage**.
- ❑ Enable and set **limit** value (optional).
- ❑ **Disconnect** tested installation from mains supply (and discharge insulation as required).
- ❑ **Connect** test cable to the instrument and to the item to be tested (see *Figure 5.6*).
- ❑ Press the **TEST** key to perform the measurement (double click for continuous measurement and later press to stop the measurement).
- ❑ After the measurement is finished wait until tested item is fully discharged.
- ❑ **Store** the result by pressing the **MEM** key (MI 3100 SE only).



Figure 5.7: Example of insulation resistance measurement result

Displayed results:

R.....insulation resistance

Umtest voltage (actual value)

5.3 Resistance of earth connection and equipotential bonding

The resistance measurement is performed in order to ensure that the protective measures against electric shock through earth connections and bondings are effective. The following continuity sub-functions are available:

- r1,
- rN,
- r2,
- R1+R2,
- R2,
- R1+RN,
- RLOW Ω and
- Continuity.

It is important to select the appropriate sub-function in order to classify the measurement to be correctly considered in verification documents (Electrical Installation Certificate, Periodic Inspection Report etc.). The r₁, r_N, r₂, R₁+R₂ and R₂ continuity tests are carried out between L and PE terminals in the same way regardless of which sub-function is selected. The R₁+R_N, RLOW Ω and Continuity tests are carried out between L and N terminals.

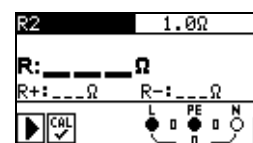

Figure 5.8: R2 continuity

See chapter 4.2 **Function selection** for instructions on key functionality.

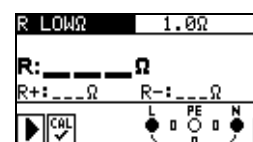



Figure 5.9: 200 mA RLOW Ω

Test parameters for resistance measurement

Test	Resistance measurement sub-function [r1, r2, rN, R2, R1+R2, R1+RN, RLOW Ω , CONTINUITY]
Limit	Maximum resistance [OFF, 0.1 Ω ÷ 20.0 Ω]

Additional test parameter for **Continuity sub-function**

	Buzzer On (sound if resistance is lower than the set limit value) or Off
---	---

Additional key:

HELP	<i>Click</i>	Calibrates test leads in Continuity functions.
	<i>Keep pressed for 1s</i>	Enters Help screen

5.3.1 Continuous resistance measurement

The Continuity measurement is performed with automatic polarity reversal of the test voltage according to BS EN 61557-4.

Test circuit for continuity measurement

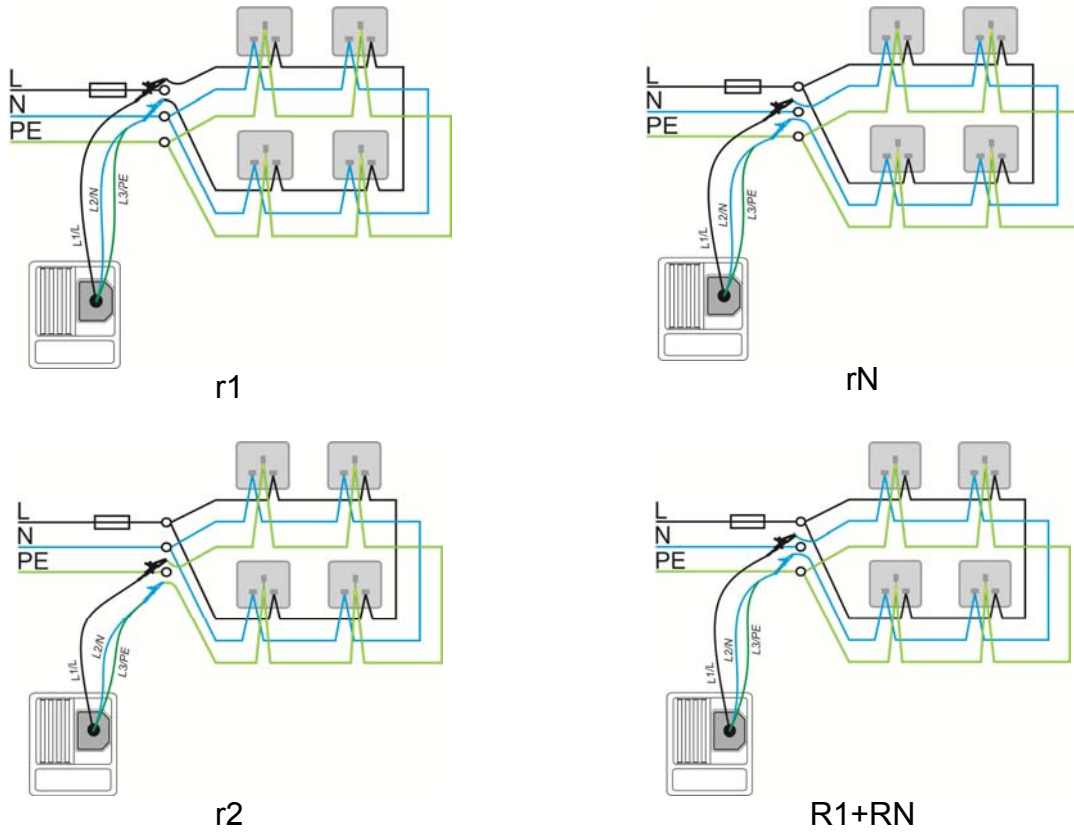

Figure 5.10: Connections for testing the r1, rN, r2 and R1+RN sections of the wiring in ring circuits

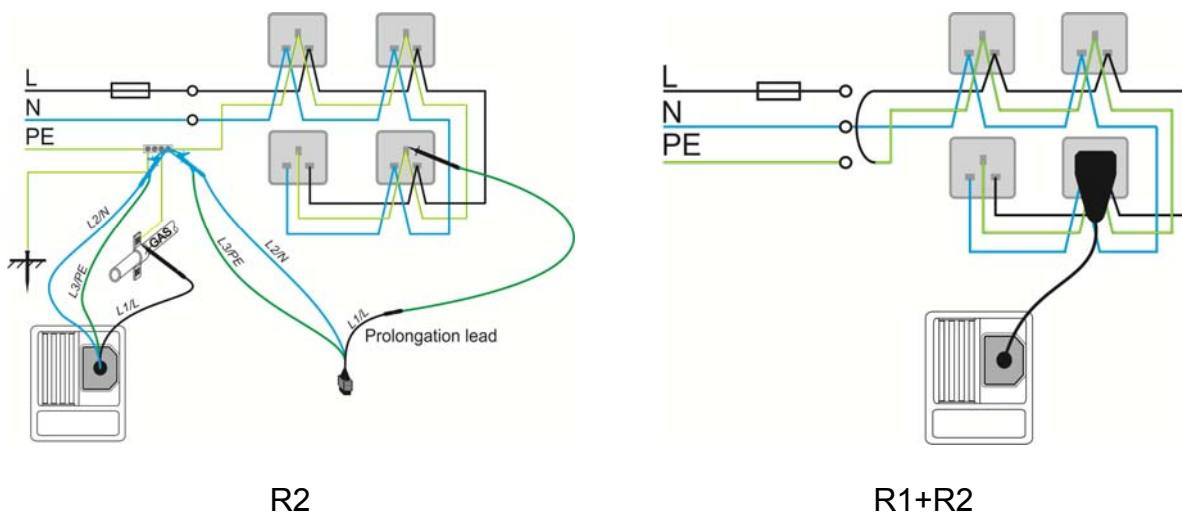

Figure 5.11: Connections for testing the R2 and R1+R2 sections of the wiring in final circuits

Continuity measurement procedure

- ❑ Select **CONTINUITY** function using the function selector switch.
- ❑ Set sub-function to (**r1**, **rN**, **r2**, **R1+R2**, **R2** or **R1+RN**) with **UP / DOWN** keys.
- ❑ Enable and set limit (optional).
- ❑ **Connect** test cable to the instrument.
- ❑ **Compensate** the test leads resistance (if necessary, see section 5.3.4 *Compensation of test leads resistance*).
- ❑ **Disconnect** tested installation from mains supply.
- ❑ **Connect** the test leads to the appropriate PE wiring (see *Figure 5.10* and *Figure 5.11*:).
- ❑ Press the **TEST** key to perform the measurement.
- ❑ After the measurement is finished **store** the result by pressing the **MEM** key (MI 3100 SE only).

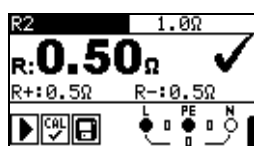

Figure 5.12: Example of continuity result

Displayed result:

- R**.....continuity resistance
- R+**result at positive polarity
- R-**result at negative test polarity

5.3.2 R LOW Ω , 200 mA resistance measurement

The resistance measurement is performed with automatic polarity reversal of the test voltage.

Test circuit for R LOW Ω measurement

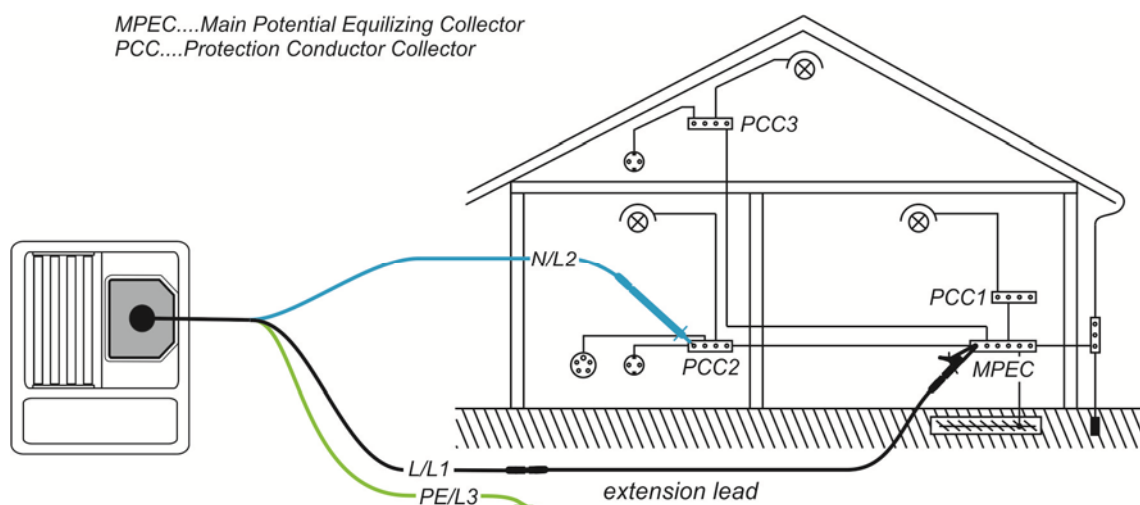

Figure 5.13: Connection of 3-wire test lead plus optional extension lead

R LOW Ω measurement procedure

- ❑ Select **CONTINUITY** function using the function selector switch.
- ❑ Set sub-function to **R LOW Ω** with **UP / DOWN** keys.
- ❑ Enable and set **limit** (optional).
- ❑ **Connect** test cable to the instrument.
- ❑ **Compensate** the test leads resistance (if necessary, see section 5.3.4 *Compensation of test leads resistance*).
- ❑ **Disconnect** from mains supply and discharge installation to be tested.
- ❑ **Connect** the test leads to the appropriate PE wiring (see *Figure 5.13*).
- ❑ Press the **TEST** key to perform the measurement.
- ❑ After the measurement is finished **store** the result by pressing the **MEM** key (MI 3100 SE only).

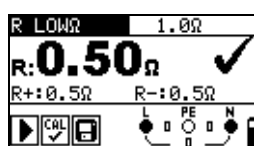

Figure 5.14: Example of RLOW result

Displayed result:

- R**.....R LOW Ω resistance
- R+**result at positive polarity
- R-**result at negative test polarity

5.3.3 Continuous resistance measurement with low current

In general, this function serves as standard Ω -meter with a low testing current. The measurement is performed continuously without polarity reversal. The function can also be applied for testing continuity of inductive components.

Test circuit for continuous resistance measurement

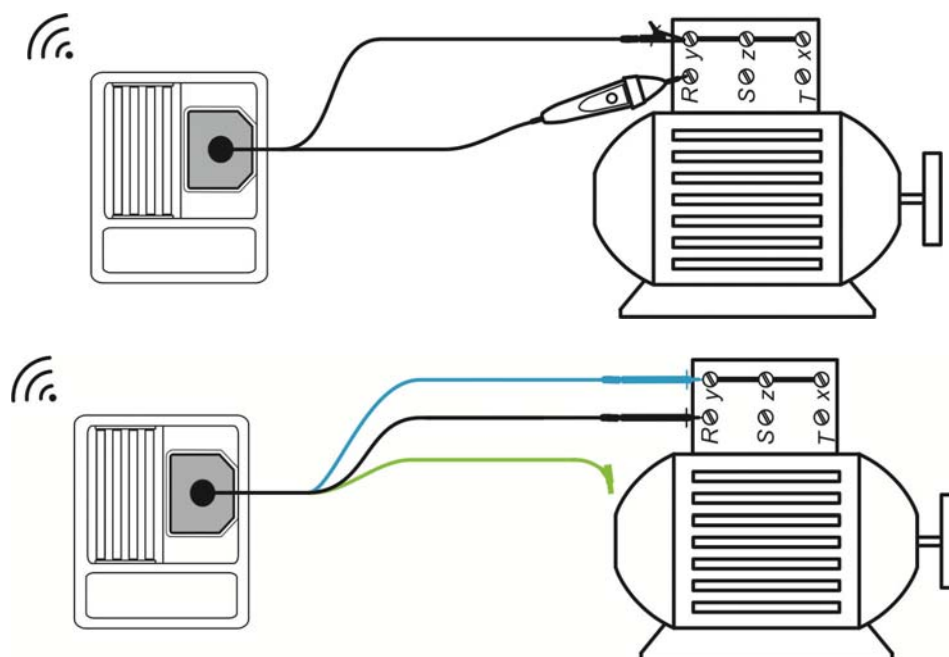

Figure 5.15: Tip commander and 3-wire test lead applications

Continuous resistance measurement procedure

- ❑ Select **CONTINUITY** function using the function selector switch.
- ❑ Set sub-function **CONTINUITY** with **UP / DOWN** keys.
- ❑ Enable and set the **limit** (optional).
- ❑ **Connect** test cable to the instrument.
- ❑ **Compensate** test leads resistance (if necessary, see section 5.3.4 *Compensation of test leads resistance*).
- ❑ **Disconnect** from mains supply and discharge the object to be tested.
- ❑ **Connect** test leads to the tested object (see Figure 5.15:).
- ❑ Press the **TEST** key to begin performing a continuous measurement.
- ❑ Press the **TEST** key to stop measurement.
- ❑ After the measurement is finished **store** the result by pressing the **MEM** key (MI 3100 SE only).

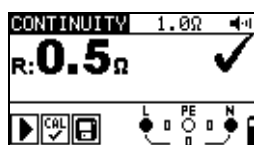

Figure 5.16: Example of continuous resistance measurement

Displayed result:

R.....resistance

5.3.4 Compensation of test leads resistance

This chapter describes how to compensate the test leads resistance in Continuity function. Compensation is required to eliminate the influence of test leads resistance and the internal resistances of the instrument on the measured resistance. The lead compensation is therefore very important to obtain correct result. There are two separated calibration values:

- one for r_1 , r_N , r_2 , R_1+R_2 and R_2 ,
- one for R_1+R_N , $R_{low\Omega}$ and Continuity.

The  symbol is displayed in the Continuity message fields if the compensation was carried out successfully.

Circuits for compensating the resistance of test leads



Figure 5.17: Examples of connections for compensation

Compensation of test leads resistance procedure

- Select the **CONTINUITY** function using the function selector switch.
- **Connect** test cable to the instrument and short the test leads together appropriately (see Figure 5.17:).
- Press the **CAL** key to perform test lead compensation.
- If the leads were successfully calibrated the resistance with old calibration data is displayed first and 0.00 Ω afterwards.



Figure 5.18: Results with old (left) and new (right) calibration values

Notes:

- The highest value for lead compensation is 5 Ω . If the resistance is higher the compensation value is set back to default value.
-  is displayed if no calibration value is stored.

5.4 Ring continuity (only with EASI switch A 1214)

With Easy Switch A1214 the resistance measurements in final ring circuits can be simplified. The Easy Switch cares for correct connectivity at the switchboard. r_1 , r_N , r_2 or R_1+R_2 , R_1+R_N measurements can be performed in one go.

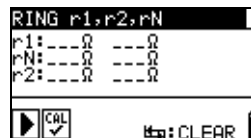

Figure 5.19: Ring continuity r_1 , r_2 , rN

See chapter 4.2 **Function selection** for instructions on key functionality.

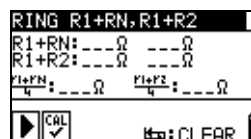

Figure 5.20: Ring continuity R_1+R_N , R_1+R_2

Test parameters for ring continuity measurement

Test	Resistance measurement sub-function [(r_1, r_2, r_N), (R_1+R_N, R_1+R_2)]
-------------	---

The ring continuity measurement is performed with automatic polarity reversal of the test voltage according to BS EN 61557-4.

Test circuit for ring continuity measurement

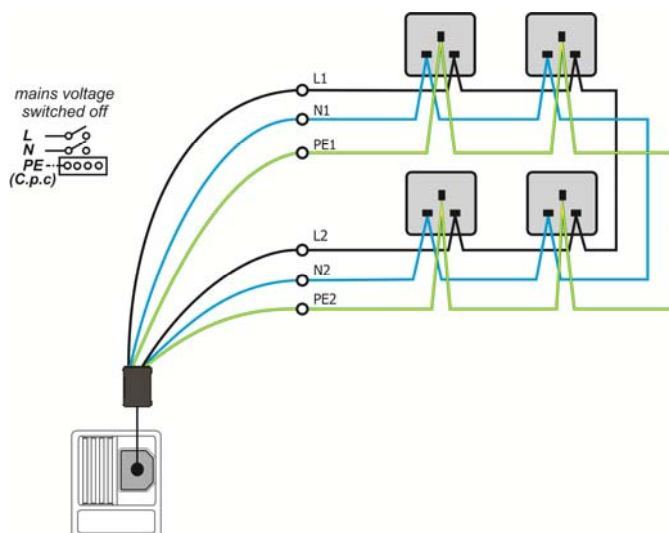

Figure 5.21: Step 1 – measurement of resistance r_1 , r_2 and rN

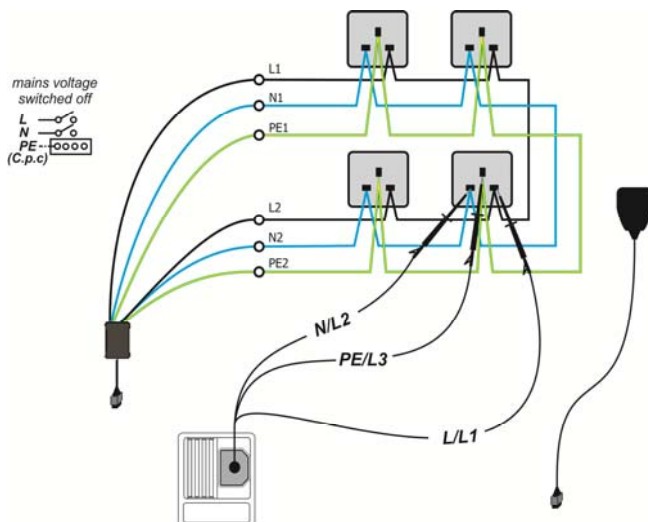

Figure 5.22: Step 2 – measurement of resistance R_1+R_N and R_1+R_2

Ring continuity measurement procedure

Step 1: r_1, r_2, r_N resistance measuring procedure

- ❑ Select **RING** function using the function selector switch.
- ❑ Set sub-function to **RING r_1, r_2, r_N** using **UP / DOWN** keys.
- ❑ **Connect** test cable to the instrument.
- ❑ **Compensate** the test leads resistance (if necessary, see section 5.3.4 *Compensation of test leads resistance*).
- ❑ **Connect** Easy switch to the instrument (see Figure 5.21:).
- ❑ **Connect** Easy switch to the final ring circuit. The electrical installation must be de-energized during the test. (See Figure 5.21:)
- ❑ Press the **TEST** key to perform the measurement of r_1, r_2 and r_N .
- ❑ **Commit** results by pressing **TAB** key to r_1, r_2 and r_N .
- ❑ The r_1, r_2 and r_N results can be cleared using the **TAB** key.
- ❑ After the measurement is finished **store** the result by pressing the **MEM** key (MI 3100 SE only).

From r_1, r_N and r_2 results reference values $(R_1+R_N)/4, (R_1+R_2)/4$ are calculated. The results are kept until they are changed or cleared. Take care that measuring leads are compensated.



Figure 5.23: Examples of ring continuity test – step 1

Displayed result:

- r1**.....ring resistance of line conductors (measured and committed)
- rN**.....ring resistance of neutral conductors (measured and committed)

r_2ring resistance of protective conductors (measured and committed)

Step 2: R1+RN, R1+R2 resistance measuring procedure

- Easy switch must stay connected to the final ring circuit The electrical installation must be de-energized during the test (see *Figure 5.22:*).
- Select **RING** function using the function selector switch.
- Set sub-function to **RING R1+RN, R1+R2** using **UP / DOWN** key.
- **Connect** plug cable or test cable to the instrument.
- **Compensate** the test leads resistance (if necessary, see chapter 5.3.4 *Compensation of test leads resistance*).
- **Connect** plug cable or test cable to a socket in final ring circuit.
- Press the **TEST** key to perform the measurement.
- For correct ring wiring the results must be approximately the same as reference value $(r_1+r_N)/4$ and $(r_1+r_2)/4$. The resistance R1+R2 slightly increases with length if cross-section of PE conductor is smaller than of line conductor.
- **Commit** results by pressing **TAB** key to R1+RN and R1+R2 positions.
- Perform measurement on the next socket in final ring circuit.
- **Commit** results by pressing **TAB** key again. The results will be committed only if they are higher as the previous results.
- The R1+RN and R1+R2 results can be cleared with the **TAB** key
- **Repeat** the measurement on all sockets of the final ring circuit.
- The R1+RN and R1+R2 **results can be cleared** with the TAB key.
- After the measurement are finished **store** the result by pressing the **MEM** key (MI 3100 SE only).



Figure 5.24: Examples of ring continuity test – step 2

Displayed results:

R1+RNreference test value, committed and measured

R1+R2.....reference test value, committed and measured

(r1+r2)/4 ..calculated reference value

(r1+rN)/4 .calculated reference value

5.5 Testing RCDs

Various test and measurements are required for verification of RCD(s) in RCD protected installations. Measurements are based on the EN 61557-6 standard.

The following measurements and tests (sub-functions) can be performed:

- contact voltage,
- trip-out time,
- trip-out current and
- RCD autotest.

See chapter 4.2 *Function selection* for instructions on key functionality.

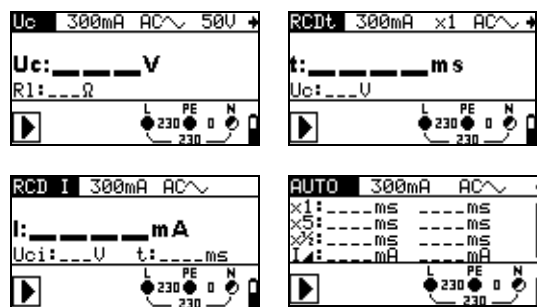

Figure 5.25: RCD tests

Test parameters for RCD test and measurement

TEST	RCD sub-function test [Uc, RCDt, RCD I, AUTO]
I _{ΔN}	Rated RCD residual current sensitivity I_{ΔN} [10 mA, 30 mA, 100 mA, 300 mA, 500 mA, 1000 mA].
type	RCD type [AC, A, F]. starting polarity [~,,~,,~,,v~]. Characteristic and PRCD selection [selective <input checked="" type="checkbox"/> , general non-delayed <input type="checkbox"/> , PRCD, PRCD-K, PRCD-S].
MUL	Multiplication factor for test current [½, 1, 2, 5 I _{ΔN}].
Ulim	Conventional touch voltage limit [25 V, 50 V].

Notes:

- Ulim can be selected in the Uc sub-function only.
- Selective (time-delayed) RCDs have delayed response characteristics. As the contact voltage pre-test or other RCD tests influence the time delayed RCD it takes a certain period to recover into normal state. Therefore a time delay of 30 s is inserted before performing trip-out test by default.
- Portable RCDs (PRCD, PRCD-K and PRCD-S) are tested as general (non-delayed) RCDs. Trip-out times, trip-out currents and contact voltage limits are equal to limits of general (non-delayed) RCDs.

Connections for testing RCD

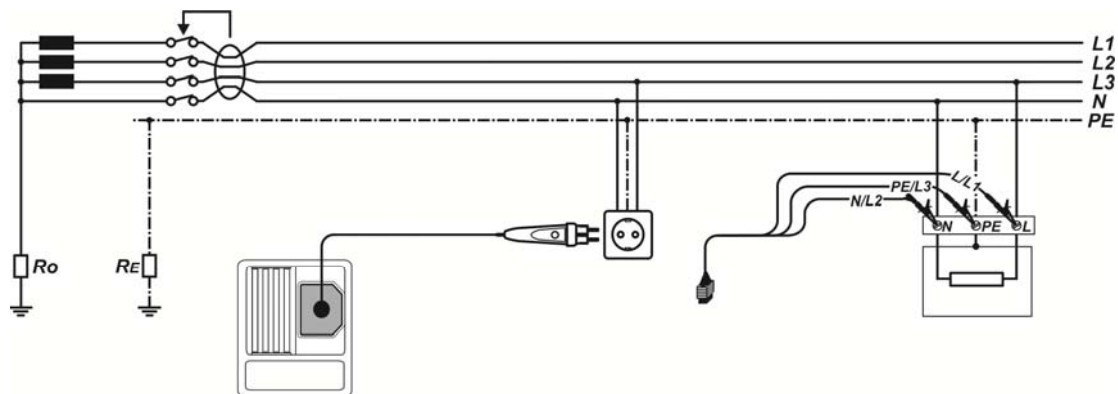

Figure 5.26: Connecting the plug test cable and the 3-wire test lead

5.5.1 Contact voltage (RCD Uc)

A current flowing into the PE terminal causes a voltage drop on earth resistance, i.e. voltage difference between PE equipotential bonding circuit and earth. This voltage difference is called contact voltage and is present on all accessible conductive parts connected to the PE. It shall always be lower than the conventional safety limit voltage. The contact voltage is measured with a test current lower than $\frac{1}{2} I_{\Delta N}$ to avoid trip-out of the RCD and then normalized to the rated $I_{\Delta N}$.

Contact voltage measurement procedure

- ❑ Select the **RCD** function using the function selector switch.
- ❑ Set sub-function to **Uc** using **UP / DOWN** keys.
- ❑ Set test **parameters** (if necessary).
- ❑ **Connect** test cable to the instrument.
- ❑ **Connect** test leads to the item to be tested (see *Figure 5.26*).
- ❑ Press the **TEST** key to perform the measurement.
- ❑ **Store** the result by pressing the **MEM** key (MI 3100 SE only).

The contact voltage result relates to the rated nominal residual current of the RCD and is multiplied by an appropriate factor (depending on RCD type and type of test current). The 1.05 factor is applied to avoid negative tolerance of result. See *Table 5.1* for detailed contact voltage calculation factors.

RCD type		Contact voltage U_c proportional to	Rated $I_{\Delta N}$
AC	<input type="checkbox"/>	$1.05 \times I_{\Delta N}$	any
AC	<input type="checkbox"/> S	$2 \times 1.05 \times I_{\Delta N}$	
A, F	<input type="checkbox"/>	$1.4 \times 1.05 \times I_{\Delta N}$	≥ 30 mA
A, F	<input type="checkbox"/> S	$2 \times 1.4 \times 1.05 \times I_{\Delta N}$	
A, F	<input type="checkbox"/>	$2 \times 1.05 \times I_{\Delta N}$	< 30 mA
A, F	<input type="checkbox"/> S	$2 \times 2 \times 1.05 \times I_{\Delta N}$	

Table 5.1: Relationship between U_c and $I_{\Delta N}$

Loop resistance is indicative and calculated from U_c result (without additional proportional factors) according to: $R_L = \frac{U_c}{I_{\Delta N}}$.



Figure 5.27: Example of contact voltage measurement results

Displayed results:

- Uc**..... contact voltage
- RI**..... fault loop resistance
- Rmax** Maximum earth fault loop resistance value according to BS 7671

5.5.2 Trip-out time (RCDt)

Trip-out time measurement verifies the sensitivity of the RCD at different residual currents.

Trip-out time measurement procedure

- Select the **RCD** function using the function selector switch.
- Set sub-function to **RCDt** using **UP / DOWN** keys.
- Set test **parameters** (if necessary).
- Connect** test cable to the instrument.
- Connect** test leads to the item to be tested (see Figure 5.26).
- Press the **TEST** key to perform the measurement.
- Store** the result by pressing the **MEM** key (MI 3100 SE only).

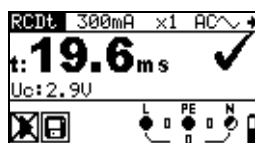

Figure 5.28: Example of trip-out time measurement results

Displayed results:

- t**.....trip-out time
- Uc**.....contact voltage for rated $I_{\Delta N}$

5.5.3 Trip-out current (RCD I)

A continuously rising residual current is intended for testing the threshold sensitivity for RCD trip-out. The instrument increases the test current in small steps through appropriate range as follows:

RCD type	Slope range	Waveform	Notes
----------	-------------	----------	-------

	Start value	End value		
AC	$0.2 \times I_{\Delta N}$	$1.1 \times I_{\Delta N}$	Sine	All models
A, F ($I_{\Delta N} \geq 30 \text{ mA}$)	$0.2 \times I_{\Delta N}$	$1.5 \times I_{\Delta N}$	Pulsed	
A, F ($I_{\Delta N} = 10 \text{ mA}$)	$0.2 \times I_{\Delta N}$	$2.2 \times I_{\Delta N}$		

Maximum test current is I_{Δ} (trip-out current) or end value in case the RCD didn't trip-out.

Trip-out current measurement procedure

- ❑ Select the **RCD** function using the function selector switch.
- ❑ Set sub-function to **RCD I** using **UP / DOWN** keys.
- ❑ Set test **parameters** (if necessary).
- ❑ **Connect** test cable to the instrument.
- ❑ **Connect** test leads to the item to be tested (see *Figure 5.26*).
- ❑ Press the **TEST** key to perform the measurement.
- ❑ **Store** the result by pressing the **MEM** key (MI 3100 SE only).

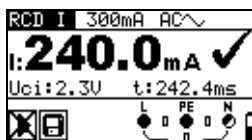

Figure 5.29: Trip-out current measurement result example

Displayed results:

Itrip-out current

Ucicontact voltage at trip-out current I or end value in case the RCD didn't trip

ttrip-out time

5.5.4 RCD Autotest

RCD autotest function is intended to perform a complete RCD test (trip-out time at different residual currents, trip-out current and contact voltage) in one set of automatic tests, guided by the instrument.

Additional key:

HELP	<i>Click</i>	Toggles between top and bottom part of results field.
	<i>Keep pressed for 1s</i>	Enters Help screen

RCD autotest procedure

RCD Autotest steps	Notes
<ul style="list-style-type: none"> □ Select the RCD function using the function selector Switch. □ Set sub-function to AUTO using . □ Set test parameters (if necessary). □ Connect test cable to the instrument. □ Connect test leads to the item to be tested (see <i>Figure 5.26</i>). □ Press the TEST key to perform the test. 	Start of test
<ul style="list-style-type: none"> □ Test with $I_{\Delta N}$, 0° (step 1). 	RCD should trip-out
<ul style="list-style-type: none"> □ Re-activate RCD. □ Test with $I_{\Delta N}$, 180° (step 2). 	RCD should trip-out
<ul style="list-style-type: none"> □ Re-activate RCD. □ Test with $5 \times I_{\Delta N}$, 0° (step 3). 	RCD should trip-out
<ul style="list-style-type: none"> □ Re-activate RCD. □ Test with $5 \times I_{\Delta N}$, 180° (step 4). 	RCD should trip-out
<ul style="list-style-type: none"> □ Re-activate RCD. □ Test with $\frac{1}{2} \times I_{\Delta N}$, 0° (step 5). □ Test with $\frac{1}{2} \times I_{\Delta N}$, 180° (step 6). 	RCD should not trip-out RCD should not trip-out
<ul style="list-style-type: none"> □ Trip-out current test, 0° (step 7). 	RCD should trip-out
<ul style="list-style-type: none"> □ Re-activate RCD. □ Trip-out current test, 180° (step 8). 	RCD should trip-out
<ul style="list-style-type: none"> □ Re-activate RCD. □ Store the result by pressing the MEM key (MI 3100 SE only). 	End of test

Result examples:

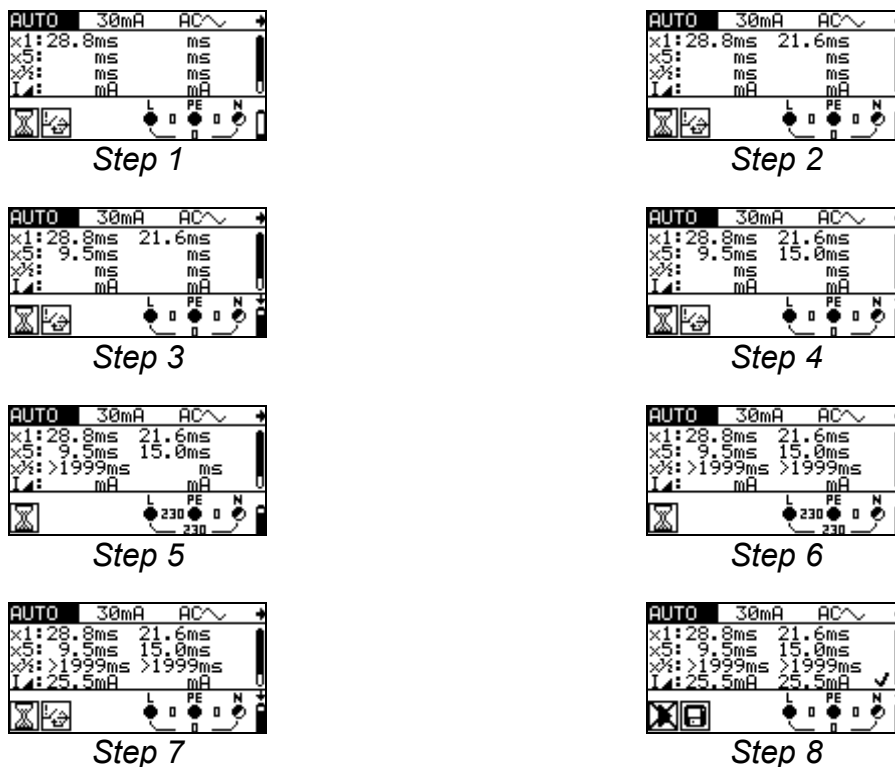

Figure 5.30: Individual steps in RCD autotest



Figure 5.31: Two parts of result field in RCD autotest

Displayed results:

- x1step 1 trip-out time ($I_{\Delta}=I_{\Delta N}$, 0°)
- x1step 2 trip-out time ($I_{\Delta}=I_{\Delta N}$, 180°)
- x5step 3 trip-out time ($I_{\Delta}=5 \times I_{\Delta N}$, 0°)
- x5step 4 trip-out time ($I_{\Delta}=5 \times I_{\Delta N}$, 180°)
- x1/2step 5 trip-out time ($I_{\Delta}=\frac{1}{2} \times I_{\Delta N}$, 0°)
- x1/2step 6 trip-out time ($I_{\Delta}=\frac{1}{2} \times I_{\Delta N}$, 180°)
- IΔstep 7 trip-out current (0°)
- IΔstep 8 trip-out current (180°)
- Uccontact voltage for rated $I_{\Delta N}$

Notes:

- The autotest sequence is immediately stopped if any incorrect condition is detected, e.g. excessive U_c or trip-out time out of bounds.
- Auto test is finished without x5 tests in case of testing the RCD types A and F with rated residual currents of $I_{\Delta N} = 300 \text{ mA}$, 500 mA , and 1000 mA . In this case auto test result passes if all other results pass, and indications for x5 are omitted.
- Tests for sensitivity (IΔ, steps 7 and 8) are omitted for selective type RCD.

5.6 Fault loop impedance and prospective fault current

Fault loop is a loop comprised by mains source, line wiring and PE path to the mains source. The instrument measures the impedance of the loop and calculates the short circuit current. The measurement is covered by requirements of the BS EN 61557-3 standard.

See chapter **4.2 Function selection** for instructions on key functionality.

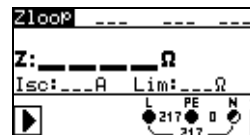

Figure 5.32: Fault loop impedance

Test parameters for fault loop impedance measurement

Test	Selection of fault loop impedance sub-function [Zloop, Zs rcd]
Fuse type	Selection of fuse type [---, BS88-2, BS3036, BS88-3, BS1362, B, C, D]
Fuse I	Rated current of selected fuse
Fuse T	Maximum breaking time of selected fuse
Lim	High limit fault loop impedance value for selected fuse

See Appendix A for reference fuse data.

Circuits for measurement of fault loop impedance

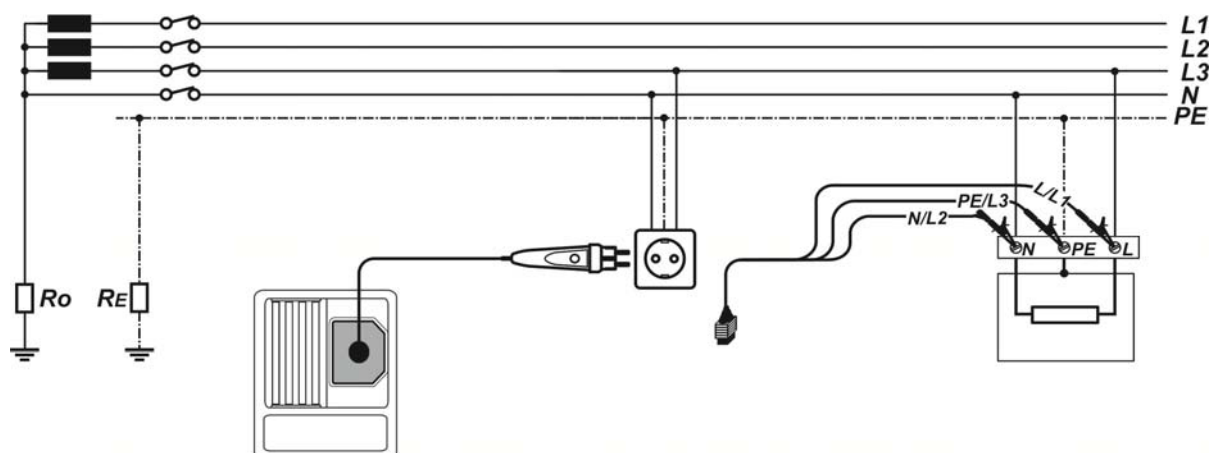

Figure 5.33: Connection of plug test cable and 3-wire test lead

Fault loop impedance measurement procedure

- ❑ Select the **Zloop** function using function selector switch.
- ❑ Set sub-function to **Zloop** or **Zs rcd** using **UP / DOWN** keys.
- ❑ Select test **parameters** (optional).
- ❑ **Connect** test cable to the instrument.
- ❑ **Connect** test leads to the item to be tested (see *Figure 5.26* and *Figure 5.33*).
- ❑ Press the **TEST** key to perform the measurement.
- ❑ **Store** the result by pressing the **MEM** key (MI 3100 SE only).



Figure 5.34: Examples of loop impedance measurement result

Displayed results:

- Z**..... fault loop impedance
- Isc** prospective fault current
- Lim**..... high limit fault loop impedance value

Prospective fault current I_{PFC} is calculated from measured impedance as follows:

$$I_{PFC} = \frac{U_N}{Z_{L-PE} \cdot scaling_factor}$$

where:

- Un Nominal U_{L-PE} voltage (see table below),
- Scaling factor..... Impedance correction factor (see chapter 4.3.5 Z factor).

Un	Input voltage range (L-PE)
110 V	$(93 V \leq U_{L-PE} \leq 134 V)$
230 V	$(185 V \leq U_{L-PE} \leq 266 V)$

Notes:

- ❑ High fluctuations of mains voltage can influence the measurement results (the noise sign  is displayed in the message field). In this case it is recommended to repeat few measurements to check if the readings are stable.
- ❑ This measurement will trip-out the RCD in RCD-protected electrical installation if test Zloop is selected.
- ❑ Select Zs rcd measurement to prevent trip-out of RCD in RCD protected installation.

5.7 Line impedance and prospective short-circuit current / Voltage drop

Line impedance is measured in loop comprising of mains voltage source and line wiring. Line impedance is covered by the requirements of the BS EN 61557-3 standard.

The Voltage drop sub-function is intended to check that a voltage in the installation stays above acceptable levels if the highest current is flowing in the circuit. The highest current is defined as the nominal current of the circuit's fuse. The limit values are described in the standard EN 60364-5-52.

Sub-functions:

- Z LINE - Line impedance measurement according to BS EN 61557-3 and
- ΔU – Voltage drop measurement.

See chapter **4.2 Function selection** for instructions on key functionality.

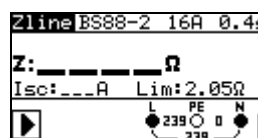

Figure 5.35: Line impedance

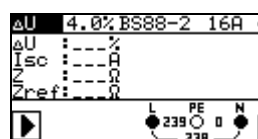

Figure 5.36: Voltage drop

Test parameters for line impedance measurement

Test	Selection of line impedance [Zline] or voltage drop [ΔU] sub-function
FUSE type	Selection of fuse type [--, BS88-2, BS3036, BS88-3, BS1362, B, C, D]
FUSE I	Rated current of selected fuse
FUSE T	Maximum breaking time of selected fuse
Lim	High limit line impedance value for selected fuse

See Appendix A for reference fuse data.

Additional test parameters for voltage drop measurement

ΔU_{MAX}	Maximum voltage drop [3.0 % ÷ 9.0 %].
-------------------------	--

Additional key:

HELP / CAL	<i>Click</i>	Measures Zref value for ΔU function.
	<i>Keep pressed for 1s</i>	Enters Help screen.

5.7.1 Line impedance and prospective short circuit current

Circuits for measurement of line impedance

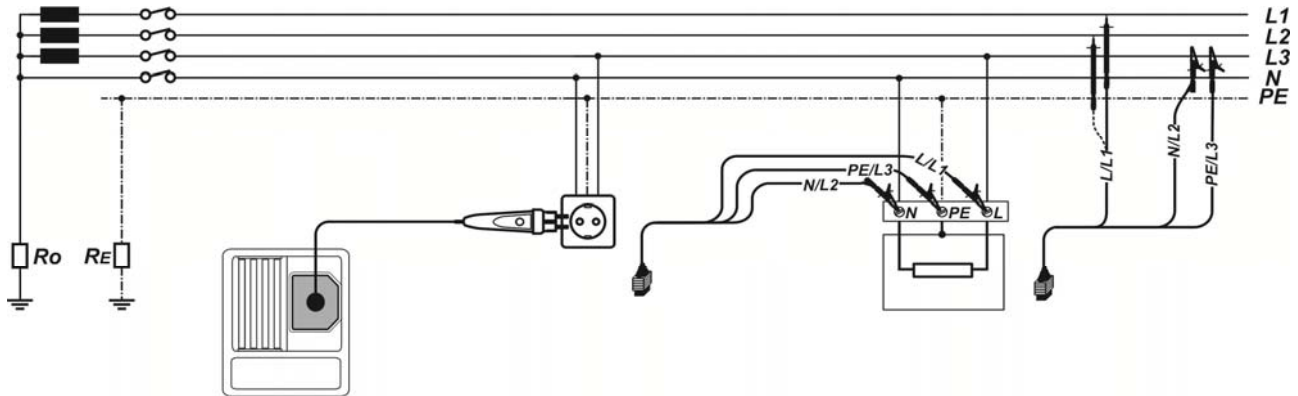

Figure 5.37: Phase-neutral or phase-phase line impedance measurement – connection of plug test cable and 3-wire test lead

Line impedance measurement procedure

- ❑ Select the **Z LINE** function using the function selector switch.
- ❑ Set sub-function to **Zline** using **UP / DOWN** keys.
- ❑ Select test **parameters** (optional).
- ❑ **Connect** test cable to the instrument.
- ❑ **Connect** test leads to the item to be tested (see Figure 5.37).
- ❑ Press the **TEST** key to perform the measurement.
- ❑ **Store** the result by pressing the **MEM** key (MI 3100 SE only).



Figure 5.38: Examples of line impedance measurement result

Displayed results:

- Z**.....line impedance
- Isc**prospective short-circuit current
- Lim**.....high limit line impedance value

Prospective fault current I_{PFC} is calculated from measured impedance as follows:

$$I_{PFC} = \frac{U_N}{Z_{L-N(L)} \cdot scaling_factor}$$

where:

- Un Nominal U_{L-N} or U_{L1-L2} voltage (see table below),
- Scaling factor Impedance correction factor (see chapter **Error! Reference source not found.**).

U_n	Input voltage range (L-N or L1-L2)
110 V	$(93 \text{ V} \leq U_{L-N} < 134 \text{ V})$
230 V	$(185 \text{ V} \leq U_{L-N} \leq 266 \text{ V})$
400 V	$(321 \text{ V} < U_{L-L} \leq 485 \text{ V})$

Note:

- High fluctuations of mains voltage can influence the measurement results (the noise sign  is displayed in the message field). In this case it is recommended to repeat few measurements to check if the readings are stable.

5.7.2 Voltage drop

The voltage drop is calculated based on the difference of line impedance at connection points (sockets) and the line impedance at the reference point (usually the impedance at the switchboard).

Circuits for measurement of voltage drop

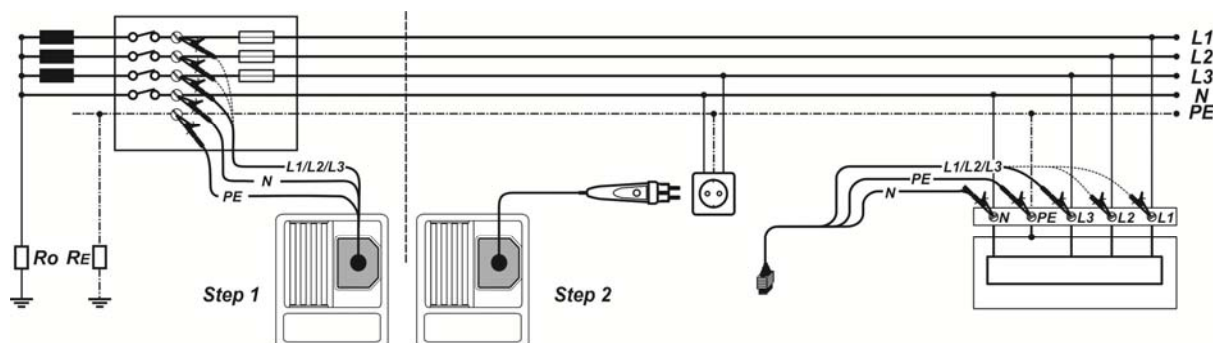

Figure 5.39: Phase-neutral or phase-phase voltage drop measurement – connection of plug test cable and 3-wire test lead

Voltage drop measurement procedure

Step 1: Measuring the impedance Z_{ref} at origin

- Select the **Z LINE** function using the function selector switch.
- Set sub-function to **ΔU** using **UP / DOWN** keys.
- Select test **parameters** (optional).
- **Connect** test cable to the instrument.
- **Connect** the test leads to the origin of electrical installation (see Figure 5.39).
- Press the **CAL** key to perform the measurement.

Step 2: Measuring the voltage drop

- Set sub-function to **ΔU** using **UP / DOWN** keys.
- Select test **parameters** (Fuse type must be selected).
- **Connect** test cable to the instrument.
- **Connect** the test leads to the tested points (see Figure 5.39).

- ❑ Press the **TEST** key to perform the measurement.
- ❑ **Store** the result by pressing the **MEM** key (MI 3100 SE only).

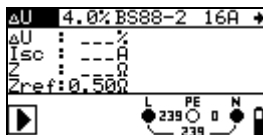

Step 1 - Zref

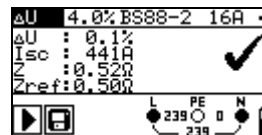

Step 2 - Voltage drop

Figure 5.40: Examples of voltage drop measurement result

Displayed results:

- ΔU** voltage drop
- Isc** prospective short-circuit current
- Z** line impedance at measured point
- Zref** reference impedance

Voltage drop is calculated as follows:

$$\Delta U[\%] = \frac{(Z - Z_{REF}) \cdot I_N}{U_N} \cdot 100$$

where:

- ΔU..... calculated voltage drop
- Z impedance at test point
- Z_{REF} impedance at reference point
- I_N rated current of selected fuse
- U_N nominal voltage (see table below)

U _n	Input voltage range (L-N or L1-L2)
110 V	(93 V ≤ U _{L-N} < 134 V)
230 V	(185 V ≤ U _{L-N} ≤ 266 V)
400 V	(321 V < U _{L-L} ≤ 485 V)

Notes:

- ❑ If the reference impedance is not set the value of Z_{REF} is considered as 0.00 Ω.
- ❑ The Z_{REF} is cleared (set to 0.00 Ω) if pressing CAL key while instrument is not connected to a voltage source.
- ❑ I_{SC} is calculated as described in chapter 5.7.1 Line impedance and prospective short circuit current.
- ❑ If the measured voltage is outside the ranges described in the table above the ΔU result will not be calculated.
- ❑ High fluctuations of mains voltage can influence the measurement results (the noise sign  is displayed in the message field). In this case it is recommended to repeat few measurements to check if the readings are stable.

5.8 Earth resistance

Earth resistance is one of the most important parameters for protection against electric shock. Main earthing arrangements, lightning systems, local earthings, soil resistivity etc can be verified with the earthing resistance test. The measurement conforms to the EN 61557-5 standard.

The Earth resistance main function is 3-wire earth resistance test method for standard earth resistance tests with two earthing rods.

See chapter **4.2 Function selection** for instructions on key functionality.

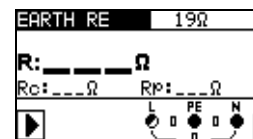

Figure 5.41: Earth resistance

Test parameters for earth resistance measurement

Test	Test configuration [EARTH RE]
Limit	Maximum resistance [OFF, 1 Ω ÷ 5 kΩ]

Earth resistance measurement procedure

- ❑ Select **EARTH** function using the function selector switch.
- ❑ Enable and set **limit** value (optional).
- ❑ **Connect** test leads to the instrument.
- ❑ **Connect** the item to be tested (see *Figure 5.42* and *Figure 5.43*).
- ❑ Press the **TEST** key to perform the measurement.
- ❑ **Store** the result by pressing the **MEM** key (MI 3100 SE only).

5.8.1 Standard earthing resistance measurement

Connections for earth resistance measurement

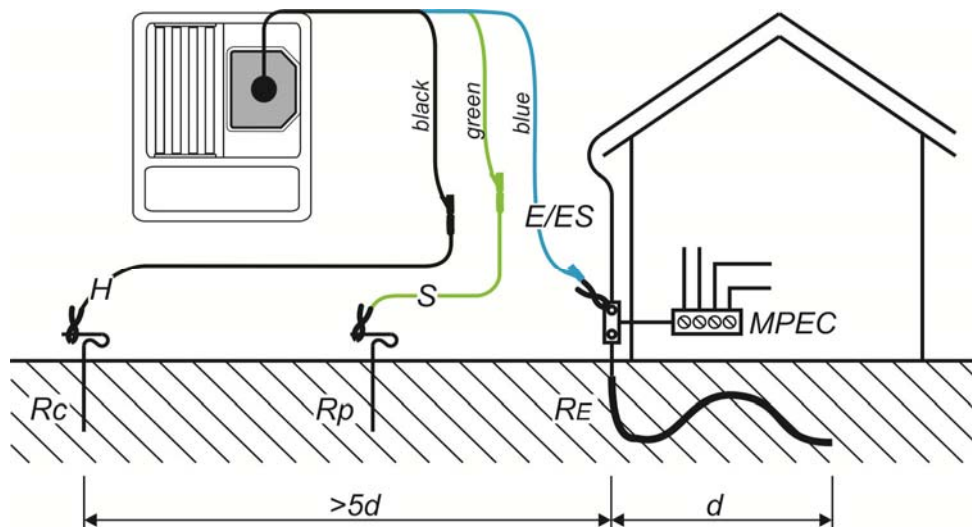

Figure 5.42: Resistance to earth, measurement of main installation earthing

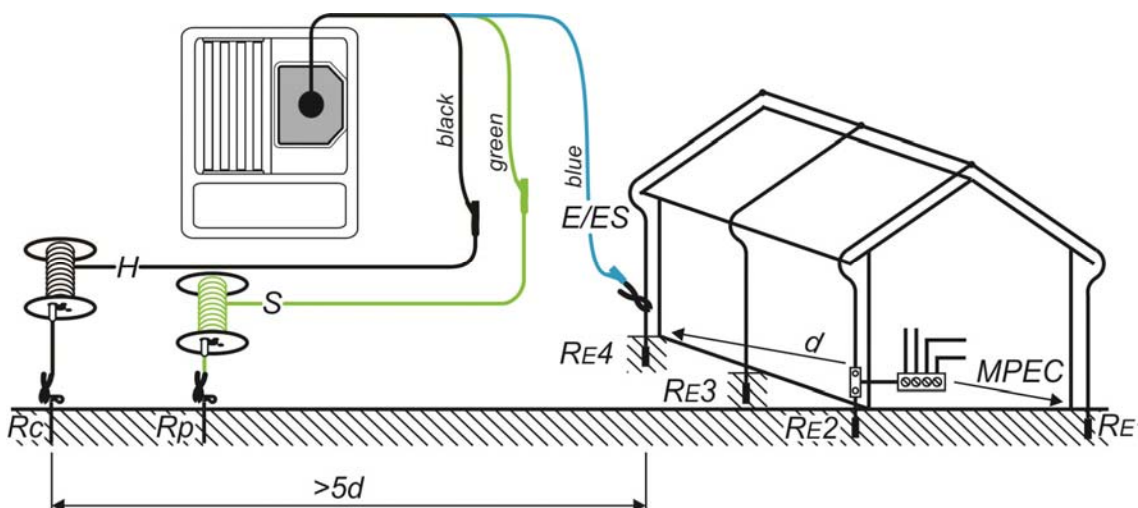

Figure 5.43: Resistance to earth, measurement of a lighting protection system



Figure 5.44: Example of earth resistance measurement result

Displayed results for earth resistance measurement:

- R..... earth resistance
- Rpresistance of S (potential) probe
- Rc.....resistance of H (current) probe

Notes:

- High resistance of S and H probes could influence the measurement results. In this case, “Rp” and “Rc” warnings are displayed. There is no PASS / FAIL indication in this case.
- High noise currents and voltages in earth could influence the measurement results. The tester displays the  warning in this case.
- Probes must be placed at sufficient distance from the measured object.

5.9 PE test terminal

It can happen that a dangerous voltage is applied to the PE wire or other accessible metal parts. This is a very dangerous situation since the PE wire and MPEs are considered to be earthed. An often reason for this fault is incorrect wiring (see examples below).

When touching the **TEST** key in all functions that requires mains supply the user automatically performs this test.

Examples for application of PE test terminal

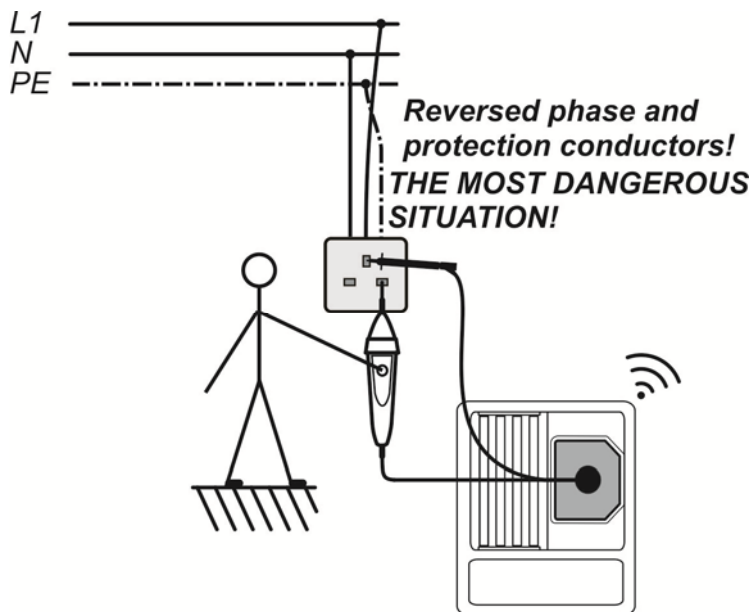

Figure 5.45: Reversed L and PE conductors (tip commander)

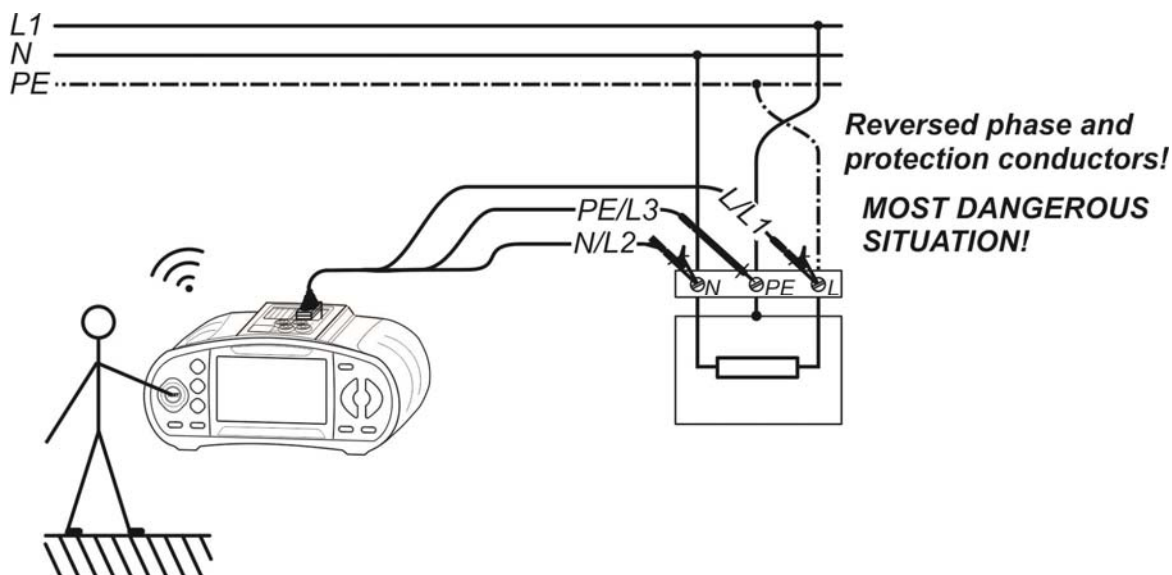

Figure 5.46: Reversed L and PE conductors (application of 3-wire test lead)

PE terminal test procedure

- ❑ **Connect** test cable to the instrument.
- ❑ **Connect** test leads to the item to be tested (see *Figure 5.45* and *Figure 5.46*)
- ❑ **Touch** PE test probe (the **TEST** key) for at least one second.
- ❑ If PE terminal is connected to phase voltage the warning message is displayed, instrument buzzer is activated, and further measurements are disabled in Zloop and RCD functions.

Warning:

- ❑ If dangerous voltage is detected on the tested PE terminal, immediately stop all measurements, find and remove the fault!

Notes:

- ❑ PE test terminal is active in the INSTALLATION operating mode (except in the VOLTAGE, Low ohm, Earth and Insulation functions).
- ❑ PE test terminal does not operate in case the operator's body is completely insulated from floor or walls!
- ❑ For operation of PE test terminal on commanders refer to chapter – *Commander*.

5.10 PE conductor resistance (MI 3100 SE only)

In TN system instrument measures the resistance of the protection conductor from the power transformer to the measurement site.

In TT system the resistance of protection conductor from mains outlet to earth electrode and back to the power transformer via soil and the transformers earthing system is measured.

See chapter **4.2 Function selection** for instructions on key functionality.

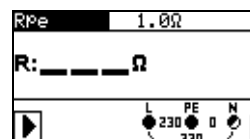

Figure 5.47: PE conductor resistance

Test parameters for PE conductor resistance measurement

Test	Selection of PE conductor resistance sub-function [Rpe, Rpe(rcd)]
Lim	Maximum resistance [OFF, 0.1 Ω ÷ 20.0 Ω].

Circuits for measurement of PE conductor resistance

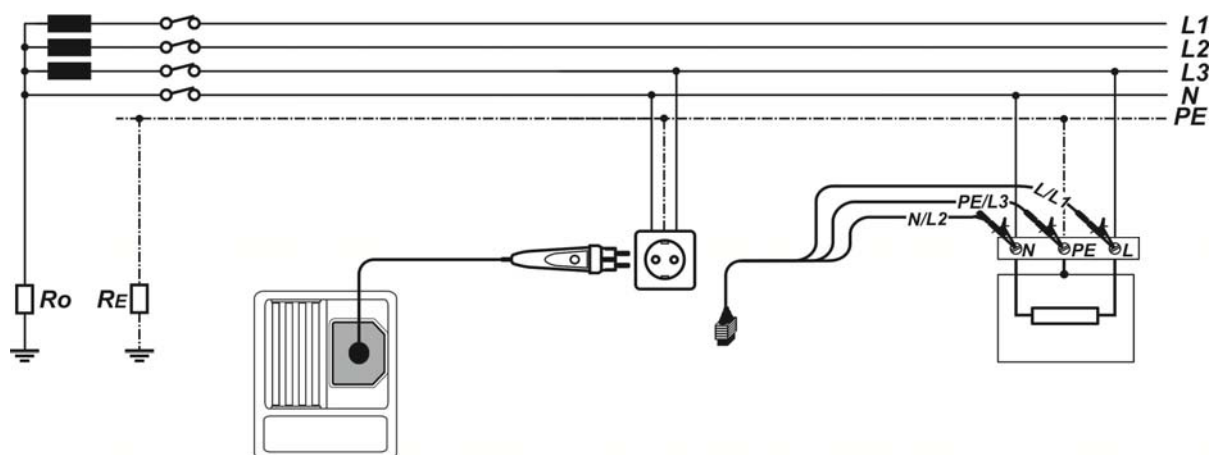

Figure 5.48: Connection of plug test cable and 3-wire test lead

PE conductor resistance measurement procedure

- ❑ Select the **Rpe** function using the function selector switch.
- ❑ Set sub-function to **Rpe** or **Rpe(rcd)** using **UP / DOWN** keys.
- ❑ Select test **parameters** (optional).
- ❑ **Connect** test cable to the instrument.
- ❑ **Connect** test leads to the item to be tested (see *Figure 5.48*).
- ❑ Press the **TEST** key to perform the measurement.
- ❑ **Store** the result by pressing the **MEM** key (optional).



Figure 5.49: Examples of PE conductor resistance measurement result

Displayed results:

R.....PE conductor resistance

Notes:

- ❑ High fluctuations of mains voltage can influence the measurement results (the noise sign  is displayed in the message field). In this case it is recommended to repeat few measurements to check if the readings are stable.
- ❑ This measurement will trip-out the RCD in RCD-protected electrical installation if test Rpe is selected.
- ❑ Select Rpe(rcd) measurement to prevent trip-out of RCD in RCD protected installation.

6 Auto-sequences (MI 3100 SE only)

Auto-sequences are intended to perform automatic executing of pre-defined measurement sequences. Sequences are divided into three groups, each for selected supply system:

- AUTO TT,
- AUTO TN (RCD) and,
- AUTO TN.

The selected sequence is carried out in one set of automatic tests, guided by the instrument.

See chapter 4.2 *Function selection* for instructions on key functionality.

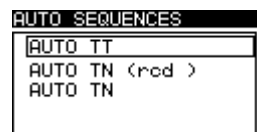

Figure 6.1: Main auto-sequence menu

Keys in main auto-sequence menu

UP / DOWN	Selects autosequence.
TEST	Enters selected autotest sequence.
Function selector switch	Exits back to selected test / measurement function.

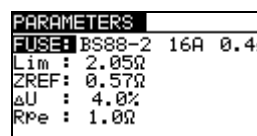
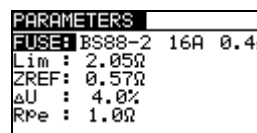
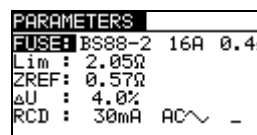
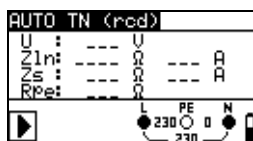
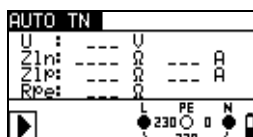
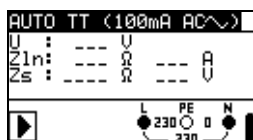

Figure 6.2: Auto-sequence menus

Figure 6.3: Editing parameters menus

Keys in autosequence and editing parameters menu

Key	Auto-sequence menu	Editing parameters menu
TAB	Enters viewing/editing test parameters.	Selects the test parameter to be set or modified.

UP / DOWN		Sets or modifies test parameters.
TEST	Runs selected autosequence.	Runs selected autosequence.
HELP / CAL <i>Click</i>	Switch between screens.	Measuring reference line impedance (when ZREF is selected).
HELP / CAL <i>Keep pressed for 1 s</i>	Enters help screens.	Enters help screens.
MEM	Stores autotest results.	
ESC	Exits back to previous menu.	Exits back to previous menu with saving changes.

The following tests / measurements can be performed for selected autosequence. Parameters in each autosequence are user-defined as follows.

Auto-sequence	Test / measurement	Available editable parameters	
AUTO TT	VOLTAGE Z LINE ΔU^* Zs rcd Uc	FUSE ZREF ΔU RCD	fuse type, rated current, maximal braking time, high limit impedance value reference line impedance voltage drop limit value nominal current, RCD type, maximal contact voltage
AUTO TN (RCD)	VOLTAGE Z LINE ΔU^* Zs rcd Rpe(rcd)	FUSE ZREF ΔU RPE	fuse type, rated current, maximal braking time, high limit impedance value reference line impedance voltage drop limit value maximal PE line resistance
AUTO TN	VOLTAGE Z LINE ΔU^* Z LOOP Rpe	FUSE ZREF ΔU RPE	fuse type, rated current, maximal braking time, high limit impedance value reference line impedance voltage drop limit value maximal PE line resistance

* applicable only if Z_{REF} is set

Circuit for automatic measurement

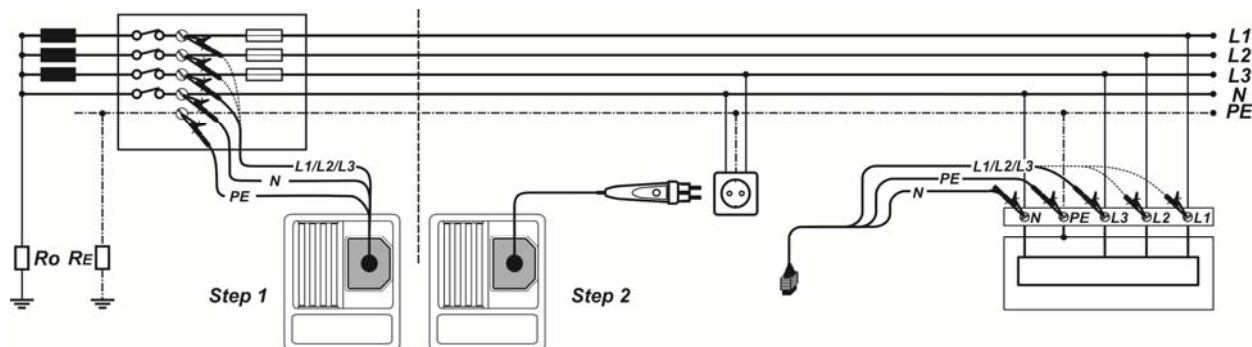

Figure 6.4: Auto-sequence setup

Automatic measurement procedure

- ❑ Select the **AUTO SEQUENCES** function using the function selector switch.
- ❑ Select autosequence **AUTO TT**, **AUTO TN (rcd)**, or **AUTO TN**.
- ❑ Select test parameters.
- ❑ **Connect** test cable to the instrument.
- ❑ **Connect** the test leads to the origin of electrical installation (see Figure 6.4 – step 1)(optional).
- ❑ Press the **CAL** key to perform the Z_{REF} measurement (optional).
- ❑ **Connect** test leads to the item to be tested (see Figure 6.4 – step 2).
- ❑ Press the **TEST** key to start the auto-sequence.
- ❑ **Store** the result by pressing the **MEM** key (optional).

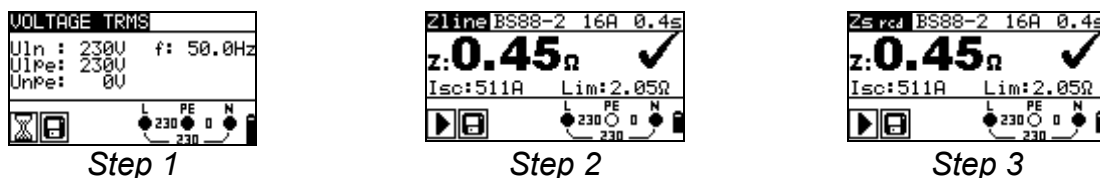

Figure 6.5: Individual steps of AUTO TT autosequence

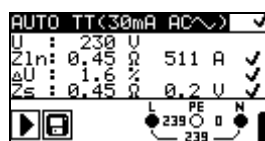

Figure 6.6: Example of AUTO TT autosequence results

Displayed results during auto-sequence and saved results

Voltage

Displayed results for single phase system:

Uln voltage between phase and neutral conductors

Ulpe voltage between phase and protective conductors

Unpe voltage between neutral and protective conductors

f frequency

Line impedance

- Z.....line impedance
- Isc.....prospective short-circuit current
- Lim.....high limit line impedance value

Loop impedance (Zs or Zs_{RCD})

- Z.....loop impedance
- Isc.....prospective fault current
- Lim.....high limit fault loop impedance value

PE conductor resistance (Rpe or Rpe_{RCD})

- R.....PE conductor resistance

Displayed results once auto-sequence finished and recalled results:

Parameter	Value	Unit	Status
Zln	0.46	Ω	495 A ✓
ΔU	0.1	V	✓
Zlp	0.49	Ω	468 A ✓
Rpe	0.00	Ω	✓

Figure 6.7: Example of recalled AUTO TN auto-sequence results

Function	Results field	
	Left value on display	Right value on display
U	Voltage	
	Voltage between phase and neutral	
Zln	Line impedance	
	Line impedance	Prospective short-circuit current
ΔU*	Voltage drop	
	Voltage drop (if available)	
Zs	Loop impedance	
	Loop impedance	Contact voltage (AUTO TT only) or Prospective fault current (AUTO TT excepted)
Zlp	Loop impedance	
	Loop impedance	Prospective fault current
Rpe	PE conductor resistance	
	PE conductor resistance	

Notes:

- Before starting the auto-sequence, all settings of parameters should be checked.
- ΔU measurement in each auto-sequence is enabled only if Z_{REF} is set.

7 Data handling (MI 3100 SE only)

7.1 Memory organization

Measurement results together with all relevant parameters can be stored in the instrument's memory. After the measurement is completed, results can be stored to the flash memory of the instrument, together with the sub-results and function parameters.

7.2 Data structure

The instrument's memory place is divided into 4 levels each containing 199 locations. The number of measurements that can be stored into one location is not limited.

The data structure field describes the location of the measurement (which object, block, fuse and connection) and where can be accessed.

In the measurement field there is information about type and number of measurements that belong to the selected structure element (object and block and fuse and connection).

The main advantages of this system are:

- Test results can be organized and grouped in a structured manner that reflects the structure of typical electrical installations.
- Customized names of data structure elements can be uploaded from EurolinkPRO PCSW.
- Simple browsing through structure and results.
- Test reports can be created with no or little modifications after downloading results to a PC.

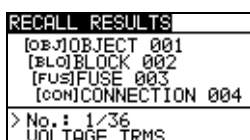

Figure 7.1: Data structure and measurement fields

Data structure field

RECALL RESULTS	Memory operation menu
[OBJ]OBJECT 001 [BLK]BLOCK 002 [FUS]FUSE 003 [CON]CONNECTION 004	Data structure field
[OBJ]OBJECT 001	1st level: OBJECT: Default location name (object and its successive number). 001: No. of selected element.
[BLK]BLOCK 002	2nd level: BLOCK: Default location name (block and its successive number). 002: No. of selected element.
[FUS]FUSE 003	3rd level:

	FUSE: Default location name (fuse and its successive number).
	003: No. of selected element.
	4th level:
[com]CONNECTION 004	CONNECTION: Default location name (connection and its successive number).
	004: No. of selected element.
	No. of measurements in selected location
No.: 20 [132]	[No. of measurements in selected location and its sub-locations]

Measurement field

VOLTAGE TRMS	Type of stored measurement in the selected location.
No.: 1/36	No. of selected test result / No. of all stored test results in selected location.

7.3 Storing test results

After the completion of a test the results and parameters are ready for storing (📁 icon is displayed in the information field). By pressing the **MEM** key, the user can store the results.

```

Save results
[OB]OBJECT 002
[BL]BLOCK 003
[FUS]FUSE 004
> [CON]CONNECTION 005
                                FREE: 96.3%
MEM : SAVE

```

Figure 7.2: Save test menu

FREE: 96.3% Memory available for storing results.

Keys in save test menu - data structure field

TAB	Selects the location element (Object / Block / Fuse / Connection)
UP / DOWN	Selects number of selected location element (1 to 199)
MEM	Saves test results to the selected location and returns to the measuring function.
ESC / TEST	Exits back to measuring function without saving.
Function selector switch	Switches to other test / measuring function or settings menu without saving.

Notes:

- ❑ The instrument offers to store the result to the last selected location by default.
- ❑ If the measurement is to be stored to the same location as the previous one just press the MEM key twice.

7.4 Recalling test results

Press the **MEM** key in every measuring function when there is no result available for storing or select MEMORY in the SETTINGS menu.

RECALL RESULTS
[OBJ]OBJECT 001
> [BLK]BLOCK 002
[FUS]-----
[CON]-----
No. : 0 [60]

Figure 7.3: Recall menu - installation structure field selected

RECALL RESULTS
[OBJ]OBJECT 001
[BLK]BLOCK 002
[FUS]FUSE 003
[CON]CONNECTION 004
> No. : 1/36
VOLTAGE TRMS

Figure 7.4: Recall menu - measurements field selected

Keys in recall memory menu (installation structure field selected):

TAB	Selects the location element (Object / Block / Fuse / Connection).
UP / DOWN	Selects number of selected location element (1 to 199).
ESC	Exits back to measuring function or memory menu.
Function selector switch	Switches to other test / measuring function or settings.
TEST / MEM	Enters measurements field.

Keys in recall memory menu (measurements field selected):

UP / DOWN	Selects the stored measurement.
TAB / ESC	Returns to installation structure field.
Function selector switch	Switches to other test / measuring function or settings.
TEST / MEM	View selected measurement results.

RCDt: 300mA x1 AC~
t: 19.6 ms ✓
Uc: 2.8V
>33/36 MEM

Figure 7.5: Example of recalled measurement result

Keys in recall memory menu (measurement results are displayed)

UP / DOWN	Displays measurement results stored in selected location.
MEM / ESC	Returns to measurements field.
TEST	Returns to installation structure field.
Function selector switch	Switches to other test / measuring function or settings.

7.5 Clearing stored data

7.5.1 Clearing complete memory content

Select **CLEAR ALL MEMORY** in **MEMORY** menu. A warning will be displayed.

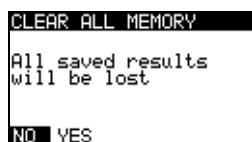

Figure 7.6: Clear all memory

Keys in clear all memory menu

TEST	Confirms clearing of complete memory content (YES must be selected with UP / DOWN keys).
ESC	Exits back to memory menu without changes.
Function selector switch	Switches to test / measuring function without changes.

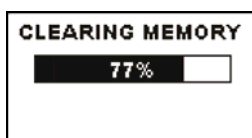

Figure 7.7: Clearing memory in progress

7.5.2 Clearing measurement(s) in selected location

Select **DELETE RESULTS** in **MEMORY** menu.

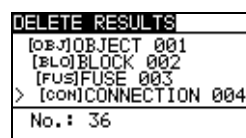
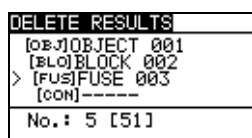

Figure 7.8: Clear measurements menu (data structure field selected)

Keys in delete results menu (installation structure field selected):

TAB	Selects the location element (Object / Block / Fuse / Connection).
UP / DOWN	Selects number of selected location element (1 to 199)
Function selector switch	Switches to test / measuring function.
ESC	Exits back to memory menu.
TEST	Enters dialog box for deleting all measurements in selected location and its sub-locations.

Keys in dialog for confirmation to clear results in selected location:

TEST	Deletes all results in selected location.
MEM / ESC	Exits back to delete results menu without changes.
Function selector switch	Switches to test / measuring function without changes.

7.5.3 Clearing individual measurements

Select **DELETE RESULTS** in **MEMORY** menu.

DELETE RESULTS
[OBJ]OBJECT 001
[BLK]BLOCK 002
[FUS]FUSE 003
[CON]CONNECTION 004
> No. : 1/36
VOLTAGE TRMS

Figure 7.9: Menu for clearing individual measurement (installation structure field selected)

Keys in delete results menu (installation structure field selected):

TAB	Selects the location element (Object / Block / Fuse / Connection).
UP / DOWN	Selects number of selected location element (1 to 199)
Function selector switch	Switches to test / measuring function.
ESC	Exits back to memory menu.
MEM	Enters measurements field for deleting individual measurements.

Keys in delete results menu (measurements field selected):

UP / DOWN	Selects measurement.
TEST	Opens dialog box for confirmation to clear selected measurement.
TAB / ESC	Returns to installation structure field.
Function selector switch	Switches to test / measuring function.

Keys in dialog for confirmation to clear selected result(s):

TEST	Deletes selected measurement result.
MEM / TAB / ESC	Exits back to measurements field without changes.
Function selector switch	Switches to test / measuring function without changes.

DELETE RESULTS
[OBJ]OBJECT 001
[BLK]BLOCK 002
[FUS]FUSE 003
[CON]CONNECTION 004
> No. : 1/36
CLEAR RESULT?

Figure 7.10: Dialog for confirmation

DELETE RESULTS
[OBJ]OBJECT 001
[BLK]BLOCK 002
[FUS]FUSE 003
[CON]CONNECTION 004
> No. : 1/35
2line

Figure 7.11: Display after measurement was cleared

7.5.4 Renaming installation structure elements (upload from PC)

Default installation structure elements are »Object«, »Block«, »Fuse« and »Connection«.

In the PCSW package Eurolink-PRO default names can be changed with customized names that corresponds the installation under test. Refer to PCSW Eurolink-PRO HELP for information how to upload customized installation names to the instrument.

RECALL RESULTS
[OBJ]APARTMENT1
[BLK]MAIN-BOARD
> [FUS]KITCHEN
No. : 72

Figure 7.12: Example of menu with customized installation structure names

7.5.5 Renaming installation structure elements with serial barcode reader or RFID reader

Default installation structure elements are »Object«, »Block«, »Fuse« and »Connection«.

When the instrument is in the SAVE RESULTS menu location ID can be scanned from a barcode label with the barcode reader or can be read from a RFID tag with the RFID reader.

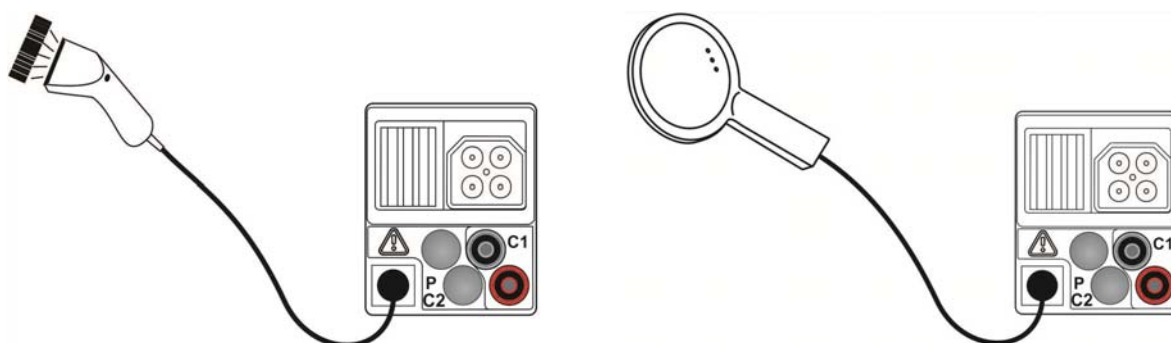

Figure 7.13: Connection of the barcode reader and RFID reader

How to change the name of memory location

- ❑ Connect the barcode reader or RFID reader to the instrument.
- ❑ In Save menu select memory location to be renamed.
- ❑ A new location name (scanned from a barcode label or a RFID tag) will be accepted by the instrument. A successful receive of the barcode or RFID tag is confirmed by two short confirmation beeps.

Note:

- ❑ Use only barcode readers and RFID readers delivered by METREL or authorized distributor.

- ❑ Switch Off and On the instrument.
- ❑ Be sure that the Bluetooth dongle A1436 is properly initialized. If not the Bluetooth dongle must be initialized as described in chapter 4.3.7 Communication (MI 3100 SE only).
- ❑ On PC configure a Standard Serial Port to enable communication over Bluetooth link between instrument and PC. Usually no code for pairing the devices is needed.
- ❑ Run the *EurolinkPRO* program.
- ❑ The PC and the instrument will automatically recognize each other.
- ❑ The instrument is prepared to communicate with the PC.

How to configure a Bluetooth link between instrument and Android device

- ❑ Switch Off and On the instrument.
- ❑ Be sure that the Bluetooth dongle A1436 is properly initialized. If not the Bluetooth dongle must be initialized as described in chapter 4.3.7 Communication (MI 3100 SE only).
- ❑ Some Android applications automatically carry out the setup of a Bluetooth connection. It is preferred to use this option if it exists.
This option is supported by Metrel's Android applications.
- ❑ If this option is not supported by the selected Android application then configure a Bluetooth link via Android device's Bluetooth configuration tool. Usually no code for pairing the devices is needed.
- ❑ The instrument and Android device are ready to communicate.

Notes:

- ❑ Sometimes there will be a demand from the PC or Android device to enter the code. Enter code 'NNNN' to correctly configure the Bluetooth link.
- ❑ The name of correctly configured Bluetooth device must consist of the instrument type plus serial number, eg. *MI 3100SE-12240429D*. If the Bluetooth module got another name, the configuration must be repeated..

8 Upgrading the instrument

The instrument can be upgraded from a PC via the RS232 communication port. This enables to keep the instrument up to date even if the standards or regulations change. The upgrade can be carried with a help of special upgrading software and the communication cable as shown on *Figure 7.14*. Please contact your dealer for more information.

9 Maintenance

Unauthorized persons are not allowed to open the Eurotest instrument. There are no user replaceable components inside the instrument, except the battery and fuses under rear cover.

9.1 Fuse replacement

There are three fuses under back cover of the Eurotest instrument.

- **F1**
M 0.315 A / 250 V, 20×5 mm
This fuse protects internal circuitry for continuity functions if test probes are connected to the mains supply voltage by mistake during measurement.
- **F2, F3**
F 4 A / 500 V, 32×6.3 mm (breaking capacity: 50 kA)
General input protection fuses of test terminals L/L1 and N/L2.

Position of fuses can be seen in *Figure 3.4: Battery and fuse compartment* in chapter 3.3 *Back side*.

Warnings:

- Disconnect all measuring accessory and switch off the instrument before opening battery / fuse compartment cover, hazardous voltage inside!
- Replace blown fuse with original type only, otherwise the instrument or accessory may be damaged and/or operator's safety impaired!

9.2 Cleaning

No special maintenance is required for the housing. To clean the surface of the instrument or accessory use a soft cloth slightly moistened with soapy water or alcohol. Then leave the instrument or accessory to dry totally before use.

Warnings:

- Do not use liquids based on petrol or hydrocarbons!
- Do not spill cleaning liquid over the instrument!

9.3 Periodic calibration

It is essential that the test instrument is regularly calibrated in order that the technical specification listed in this manual is guaranteed. We recommend an annual calibration. Only an authorized technical person can do the calibration. Please contact your dealer for further information.

9.4 Service

For repairs under warranty, or at any other time, please contact your distributor.

10 Technical specifications

10.1 Insulation resistance

Insulation resistance (nominal voltages 50 V_{DC}, 100 V_{DC} and 250 V_{DC})

Measuring range according to EN 61557 is 0.15 MΩ ÷ 199.9 MΩ.

Measuring range (MΩ)	Resolution (MΩ)	Accuracy
0.00 ÷ 19.99	0.01	±(5 % of reading + 3 digits)
20.0 ÷ 99.9	0.1	±(10 % of reading)
100.0 ÷ 199.9		±(20 % of reading)

Insulation resistance (nominal voltages 500 V_{DC} and 1000 V_{DC})

Measuring range according to EN 61557 is 0.15 MΩ ÷ 1 GΩ.

Measuring range (MΩ)	Resolution (MΩ)	Accuracy
0.00 ÷ 19.99	0.01	±(5 % of reading + 3 digits)
20.0 ÷ 199.9	0.1	±(5 % of reading)
200 ÷ 999	1	±(10 % of reading)

Voltage

Measuring range (V)	Resolution (V)	Accuracy
0 ÷ 1200	1	±(3 % of reading + 3 digits)

Nominal voltages 50 V_{DC}, 100 V_{DC}, 250 V_{DC}, 500 V_{DC}, 1000 V_{DC}

Open circuit voltage -0 % / +20 % of nominal voltage

Measuring current..... min. 1 mA at R_N=U_N×1 kΩ/V

Short circuit current..... max. 3 mA

The number of possible tests..... > 1200, with a fully charged battery

Auto discharge after test.

Specified accuracy is valid if 3-wire test lead is used while it is valid up to 100 MΩ if tip commander is used.

Specified accuracy is valid up to 100 MΩ if relative humidity > 85 %.

In case the instrument gets moistened, the results could be impaired. In such case, it is recommended to dry the instrument and accessories for at least 24 hours.

The error in operating conditions could be at most the error for reference conditions (specified in the manual for each function) ±5 % of measured value.

10.2 Continuity

10.2.1 Resistance R LOW, R2, R1+R2

Measuring range according to EN 61557 is 0.16 Ω ÷ 1999 Ω .

Measuring range R (Ω)	Resolution (Ω)	Accuracy
0.00 ÷ 19.99	0.01	$\pm(3\%$ of reading + 3 digits)
20.0 ÷ 199.9	0.1	$\pm(5\%$ of reading)
200 ÷ 1999	1	

Measuring range R+, R- (Ω)	Resolution (Ω)	Accuracy
0.0 ÷ 199.9	0.1	$\pm(5\%$ of reading + 5 digits)
200 ÷ 1999	1	

Open-circuit voltage6.5 VDC ÷ 9 VDC
 Measuring current.....min. 200 mA into load resistance of 2 Ω
 Test lead compensation.....up to 5 Ω
 The number of possible tests.....> 2000, with a fully charged battery
 Automatic polarity reversal of the test voltage.

10.2.2 Resistance CONTINUITY

Measuring range (Ω)	Resolution (Ω)	Accuracy
0.0 ÷ 19.9	0.1	$\pm(5\%$ of reading + 3 digits)
20 ÷ 1999	1	

Open-circuit voltage6.5 VDC ÷ 9 VDC
 Short-circuit currentmax. 8.5 mA
 Test lead compensation.....up to 5 Ω

10.2.3 RING Continuity

Measuring range according to EN 61557 is 0.16 Ω ÷ 1999 Ω .

Measuring range R (Ω)	Resolution (Ω)	Accuracy
0.00 ÷ 19.99	0.01	$\pm(3\%$ of reading + 3 digits)
20.0 ÷ 199.9	0.1	$\pm(5\%$ of reading)
200 ÷ 1999	1	

Open-circuit voltage.....6.5 VDC ÷ 9 VDC
 Measuring current.....min. 200 mA into load resistance of 2 Ω
 Test lead compensation.....up to 5 Ω
 The number of possible tests> 2000, with a fully charged battery

10.3 RCD testing

10.3.1 General data

Nominal residual current (A,AC)	10 mA, 30 mA, 100 mA, 300 mA, 500 mA, 1000 mA
Nominal residual current accuracy.....	-0 / +0.1·I Δ ; I Δ = I Δ N, 2×I Δ N, 5×I Δ N -0.1·I Δ / +0; I Δ = 0.5×I Δ N AS/NZS selected: ± 5 %
Test current shape.....	Sine-wave (AC), pulsed (A, F)
DC offset for pulsed test current	6 mA (typical)
RCD type	non-delayed, S (time-delayed), PRCD, PRCD-K, PRCD-S
Test current starting polarity	0° or 180°
Voltage range	93 V ÷ 134 V (45 Hz ÷ 65 Hz) 185 V ÷ 266 V (45 Hz ÷ 65 Hz)

I Δ N (mA)	I Δ N × 1/2		I Δ N × 1		I Δ N × 2		I Δ N × 5		RCD I Δ	
	AC	A, F	AC	A, F	AC	A, F	AC	A, F	AC	A, F
10	5	3.5	10	20	20	40	50	100	✓	✓
30	15	10.5	30	42	60	84	150	212	✓	✓
100	50	35	100	141	200	282	500	707	✓	✓
300	150	105	300	424	600	848	1500	n.a.	✓	✓
500	250	175	500	707	1000	1410	2500	n.a.	✓	✓
1000	500	350	1000	1410	2000	n.a.	n.a.	n.a.	✓	✓

n.a.....not applicable

AC type.....sine wave test current

A, F types.....pulsed current

10.3.2 Contact voltage RCD Uc

Measuring range according to EN 61557 is 20.0 V ÷ 31.0V for limit contact voltage 25V

Measuring range according to EN 61557 is 20.0 V ÷ 62.0V for limit contact voltage 50V

Measuring range (V)	Resolution (V)	Accuracy
0.0 ÷ 19.9	0.1	(-0 % / +15 %) of reading ± 10 digits
20.0 ÷ 99.9	0.1	(-0 % / +15 %) of reading

The accuracy is valid if mains voltage is stabile during the measurement and PE terminal is free of interfering voltages.

Test current max. 0.5×I Δ N

Limit contact voltage 25 V, 50 V

Specified accuracy is valid for complete operating range.

10.3.3 Trip-out time

Complete measurement range corresponds to EN 61557 requirements.
Maximum measuring times set according to selected reference for RCD testing.

Measuring range (ms)	Resolution (ms)	Accuracy
0.0 ÷ 40.0	0.1	±1 ms
0.0 ÷ max. time *	0.1	±3 ms

* For max. time see normative references in chapter 4.3.4 RCD testing – this specification applies to max. time >40 ms.

Test current $\frac{1}{2} \times I_{\Delta N}$, $I_{\Delta N}$, $2 \times I_{\Delta N}$, $5 \times I_{\Delta N}$

$5 \times I_{\Delta N}$ is not available for $I_{\Delta N} = 1000$ mA (RCD type AC) or $I_{\Delta N} \geq 300$ mA (RCD types A, F).

$2 \times I_{\Delta N}$ is not available for $I_{\Delta N} = 1000$ mA (RCD types A, F) Specified accuracy is valid for complete operating range.

10.3.4 Trip-out current

Trip-out current

Complete measurement range corresponds to EN 61557 requirements.

Measuring range I_{Δ}	Resolution I_{Δ}	Accuracy
$0.2 \times I_{\Delta N} \div 1.1 \times I_{\Delta N}$ (AC type)	$0.05 \times I_{\Delta N}$	$\pm 0.1 \times I_{\Delta N}$
$0.2 \times I_{\Delta N} \div 1.5 \times I_{\Delta N}$ (A type, $I_{\Delta N} \geq 30$ mA)	$0.05 \times I_{\Delta N}$	$\pm 0.1 \times I_{\Delta N}$
$0.2 \times I_{\Delta N} \div 2.2 \times I_{\Delta N}$ (A type, $I_{\Delta N} < 30$ mA)	$0.05 \times I_{\Delta N}$	$\pm 0.1 \times I_{\Delta N}$
$0.2 \times I_{\Delta N} \div 2.2 \times I_{\Delta N}$ (B type)	$0.05 \times I_{\Delta N}$	$\pm 0.1 \times I_{\Delta N}$

Trip-out time

Measuring range (ms)	Resolution (ms)	Accuracy
0 ÷ 300	1	±3 ms

Contact voltage

Measuring range (V)	Resolution (V)	Accuracy
0.0 ÷ 19.9	0.1	(-0 % / +15 %) of reading ± 10 digits
20.0 ÷ 99.9	0.1	(-0 % / +15 %) of reading

The accuracy is valid if mains voltage is stable during the measurement and PE terminal is free of interfering voltages.

Specified accuracy is valid for complete operating range.

10.4 Fault loop impedance and prospective fault current

10.4.1 No disconnecting device or FUSE selected

Fault loop impedance

Measuring range according to EN 61557 is $0.25 \Omega \div 9.99\text{k}\Omega$.

Measuring range (Ω)	Resolution (Ω)	Accuracy
0.00 \div 9.99	0.01	$\pm(5\%$ of reading + 5 digits)
10.0 \div 99.9	0.1	
100 \div 999	1	$\pm 10\%$ of reading
1.00 k \div 9.99 k	10	

Prospective fault current (calculated value)

Measuring range (A)	Resolution (A)	Accuracy
0.00 \div 9.99	0.01	Consider accuracy of fault loop resistance measurement
10.0 \div 99.9	0.1	
100 \div 999	1	
1.00 k \div 9.99 k	10	
10.0 k \div 23.0 k	100	

The accuracy is valid if mains voltage is stable during the measurement.

Test current (at 230 V)..... 6.5 A (10 ms)

Nominal voltage range..... 93 V \div 134 V (45 Hz \div 65 Hz)

185 V \div 266 V (45 Hz \div 65 Hz)

10.4.2 RCD selected

Fault loop impedance

Measuring range according to EN 61557 is $0.46 \Omega \div 9.99 \text{ k}\Omega$.

Measuring range (Ω)	Resolution (Ω)	Accuracy
0.00 \div 9.99	0.01	$\pm(5\%$ of reading + 10 digits)
10.0 \div 99.9	0.1	
100 \div 999	1	$\pm 10\%$ of reading
1.00 k \div 9.99 k	10	

Accuracy may be impaired in case of heavy noise on mains voltage.

Prospective fault current (calculated value)

Measuring range (A)	Resolution (A)	Accuracy
0.00 \div 9.99	0.01	Consider accuracy of fault loop resistance measurement
10.0 \div 99.9	0.1	
100 \div 999	1	
1.00 k \div 9.99 k	10	
10.0 k \div 23.0 k	100	

Nominal voltage range..... 93 V \div 134 V (45 Hz \div 65 Hz)

185 V \div 266 V (45 Hz \div 65 Hz)

No trip out of RCD.

10.5 Line impedance and prospective short-circuit current / Voltage drop

Line impedance

Measuring range according to EN 61557 is $0.25 \Omega \div 9.99\text{k}\Omega$.

Measuring range (Ω)	Resolution (Ω)	Accuracy
0.00 \div 9.99	0.01	$\pm(5\%$ of reading + 5 digits)
10.0 \div 99.9	0.1	
100 \div 999	1	$\pm 10\%$ of reading
1.00 k \div 9.99 k	10	

Prospective short-circuit current (calculated value)

Measuring range (A)	Resolution (A)	Accuracy
0.00 \div 0.99	0.01	Consider accuracy of line resistance measurement
1.0 \div 99.9	0.1	
100 \div 999	1	
1.00 k \div 99.99 k	10	
100 k \div 199 k	1000	

Test current (at 230 V)..... 6.5 A (10 ms)

Nominal voltage range..... 93 V \div 134 V (45 Hz \div 65 Hz)

185 V \div 266 V (45 Hz \div 65 Hz)

321 V \div 485 V (45 Hz \div 65 Hz)

Voltage drop (calculated value)

Measuring range (%)	Resolution (%)	Accuracy
0.0 \div 99.9	0.1	Consider accuracy of line impedance measurement(s)*

Z_{REF} measuring range 0.00 $\Omega \div$ 20.0 Ω

*See chapter 5.7.2 *Voltage drop* for more information about calculation of voltage drop result

10.6 PE conductor resistance (MI 3100 SE only)

10.6.1 No RCD selected

PE conductor resistance

Measuring range (Ω)	Resolution (Ω)	Accuracy
0.00 ÷ 19.99	0.01	±(5 % of reading + 5 digits)
20.0 ÷ 99.9	0.1	
100.0 ÷ 199.9	0,1	± 10 % of reading
200 ÷ 1999	1	

10.6.2 RCD selected

PE conductor resistance

Measuring range (Ω)	Resolution (Ω)	Accuracy
0.00 ÷ 19.99	0.01	±(5 % of reading + 10 digits)
20.0 ÷ 99.9	0.1	
100.0 ÷ 199.9	0,1	± 10 % of reading
200 ÷ 1999	1	

Accuracy may be impaired in case of heavy noise on mains voltage.

Nominal voltage range..... 93 V ÷ 134 V (45 Hz ÷ 65 Hz)
185 V ÷ 266 V (45 Hz ÷ 65 Hz)

No trip out of RCD.

10.7 Resistance to earth

10.7.1 Standard earthing resistance measurement – 3-wire measurement

Measuring range according to EN61557-5 is $2.00 \Omega \div 1999 \Omega$.

Measuring range (Ω)	Resolution (Ω)	Accuracy
0.00 \div 19.99	0.01	$\pm(5\%$ of reading + 5 digits)
20.0 \div 199.9	0.1	
200 \div 9999	1	

Max. auxiliary earth electrode resistance R_C ... $100 \times R_E$ or $50 \text{ k}\Omega$ (whichever is lower)

Max. probe resistance R_P $100 \times R_E$ or $50 \text{ k}\Omega$ (whichever is lower)

Additional probe resistance error at R_{Cmax} or R_{Pmax} . $\pm(10 \%$ of reading + 10 digits)

Additional error at 3 V voltage noise (50 Hz) ... $\pm(5 \%$ of reading + 10 digits)

Open circuit voltage $< 30 \text{ VAC}$

Short circuit current..... $< 30 \text{ mA}$

Test voltage frequency 125 Hz

Test voltage shape sine wave

Noise voltage indication threshold $1 \text{ V} (< 50 \Omega, \text{ worst case})$

Automatic measurement of auxiliary electrode resistance and probe resistance.

Automatic measurement of voltage noise.

10.8 Voltage, frequency, and phase rotation

10.8.1 Phase rotation

Nominal system voltage range 100 V_{AC} ÷ 550 V_{AC}

Nominal frequency range..... 14 Hz ÷ 500 Hz

Result displayed 1.2.3 or 3.2.1

10.8.2 Voltage

Measuring range (V)	Resolution (V)	Accuracy
0 ÷ 550	1	±(2 % of reading + 2 digits)

Result type..... True r.m.s. (trms)

Nominal frequency range..... 0 Hz, 14 Hz ÷ 500 Hz

10.8.3 Frequency

Measuring range (Hz)	Resolution (Hz)	Accuracy
0.00 ÷ 9.99	0.01	±(0.2 % of reading + 1 digit)
10.0 ÷ 499.9	0.1	

Nominal voltage range..... 10 V ÷ 550 V

10.8.4 Online terminal voltage monitor

Measuring range (V)	Resolution (V)	Accuracy
10 ÷ 550	1	±(2 % of reading + 2 digits)

10.9 General data

Power supply voltage.....	9 V _{DC} (6×1.5 V battery or accu, size AA)
Operation.....	typical 20 h
Charger socket input voltage	12 V ± 10 %
Charger socket input current	400 mA max.
Battery charging current	250 mA (internally regulated)
Measuring category	600 V CAT III 300 V CAT IV
Protection classification	double insulation
Pollution degree.....	2
Protection degree	IP 40

Display..... 128x64 dots matrix display with backlight

Dimensions (w × h × d)..... 23 cm × 10.3 cm × 11.5 cm

Weight

1.3 kg, without battery cells

Reference conditions

Reference temperature range..... 10 °C ÷ 30 °C

Reference humidity range..... 40 %RH ÷ 70 %RH

Operation conditions

Working temperature range

0 °C ÷ 40 °C

Maximum relative humidity

95 %RH (0 °C ÷ 40 °C), non-condensing

Storage conditions

Temperature range..... -10 °C ÷ +70 °C

Maximum relative humidity

90 %RH (-10 °C ÷ +40 °C)
80 %RH (40 °C ÷ 60 °C)

Communication transfer speed

RS 232..... 57600 baud

USB

256000 baud

Size of memory (MI 3100 SE only) ... ca 1800 measurements

The error in operating conditions could be at most the error for reference conditions (specified in the manual for each function) +1 % of measured value + 1 digit, unless otherwise specified in the manual for particular function.

Appendix A – Fuse table

A.2 Fuse table – impedances (UK)

Fuse type B

Rated current (A)	Disconnection time [s]	
	0.4	5
	Max. loop impedance (Ω)	
3	12,264	12,264
6	6,136	6,136
10	3,68	3,68
16	2,296	2,296
20	1,84	1,84
25	1,472	1,472
32	1,152	1,152
40	0,92	0,92
50	0,736	0,736
63	0,584	0,584
80	0,456	0,456
100	0,368	0,368
125	0,296	0,296

Fuse type C

Rated current (A)	Disconnection time [s]	
	0.4	5
	Max. loop impedance (Ω)	
6	3,064	3,064
10	1,84	1,84
16	1,152	1,152
20	0,92	0,92
25	0,736	0,736
32	0,576	0,576
40	0,456	0,456
50	0,368	0,368
63	0,288	0,288
80	0,232	0,232
100	0,184	0,184
125	0,144	0,144

Fuse type D

Rated current (A)	Disconnection time [s]	
	0.4	5
	Max. loop impedance (Ω)	
6	1,536	1,536
10	0,92	0,92
16	0,576	0,576
20	0,456	0,456
25	0,368	0,368
32	0,288	0,288
40	0,232	0,232
50	0,184	0,184
63	0,144	0,144
80	0,112	0,112
100	0,088	0,088
125	0,072	0,072

Fuse type BS 1361

Rated current (A)	Disconnection time [s]	
	0.4	5
	Max. loop impedance (Ω)	
5	8,36	13,12
15	2,624	4
20	1,36	2,24
30	0,92	1,472
45		0,768
60		0,56
80		0,4
100		0,288

Fuse type BS 88

Rated current (A)	Disconnection time [s]	
	0.4	5
	Max. loop impedance (Ω)	
6	6,816	10,8
10	4,088	5,936
16	2,16	3,344
20	1,416	2,328
25	1,152	1,84
32	0,832	1,472
40		1,08
50		0,832
63		0,656
80		0,456
100		0,336
125		0,264
160		0,2
200		0,152

Fuse type BS 1362

Rated current (A)	Disconnection time [s]	
	0.4	5
	Max. loop impedance (Ω)	
3	13,12	18,56
13	1,936	3,064

Fuse type BS 3036		
Rated current (A)	Disconnection time [s]	
	0.4	5
	Max. loop impedance (Ω)	
5	7,664	14,16
15	2,04	4,28
20	1,416	3,064
30	0,872	2,112
45		1,272
60		0,896
100		0,424

All impedances are scaled with factor 0.8.

Appendix B – Accessories for specific measurements

The table below presents recommended standard and optional accessories required for specific measurement. Please see attached list of standard accessories for your set or contact your distributor for further information.

Function	Suitable accessories (Optional with ordering code A....)
Insulation resistance	<ul style="list-style-type: none"> <input type="checkbox"/> Test lead, 3 x 1.5 m <input type="checkbox"/> Tip commander (A 1401)
R LOW Ω resistance Continuity	<ul style="list-style-type: none"> <input type="checkbox"/> Test lead, 3 x 1.5 m <input type="checkbox"/> Tip commander (A 1401) <input type="checkbox"/> Test lead, 4 m (A 1012)
Ring continuity	<ul style="list-style-type: none"> <input type="checkbox"/> Test lead, 3 x 1.5 m <input type="checkbox"/> Ring adapter (A 1214)
Line impedance Voltage drop Fault loop impedance	<ul style="list-style-type: none"> <input type="checkbox"/> Test lead, 3 x 1.5 m <input type="checkbox"/> Mains measuring cable <input type="checkbox"/> Tip commander (A 1401) <input type="checkbox"/> Three-phase adapter with switch (A 1111)
Earth connection resistance (MI 3100 SE only)	<ul style="list-style-type: none"> <input type="checkbox"/> Test lead, 3 x 1.5 m <input type="checkbox"/> Mains measuring cable <input type="checkbox"/> Tip commander (A 1401)
RCD testing	<ul style="list-style-type: none"> <input type="checkbox"/> Test lead, 3 x 1.5 m <input type="checkbox"/> Mains measuring cable <input type="checkbox"/> Three-phase adapter with switch (A 1111)
Earth resistance - RE	<ul style="list-style-type: none"> <input type="checkbox"/> Test lead, 3 x 1.5 m <input type="checkbox"/> Earth test set, 3-wire, 20 m (S 2026) <input type="checkbox"/> Earth test set, 3-wire, 50 m (S 2027)
Phase sequence	<ul style="list-style-type: none"> <input type="checkbox"/> Test lead, 3 x 1.5 m <input type="checkbox"/> Three-phase adapter (A 1110) <input type="checkbox"/> Three-phase adapter with switch (A 1111)
Voltage, frequency	<ul style="list-style-type: none"> <input type="checkbox"/> Test lead, 3 x 1.5 m <input type="checkbox"/> Mains measuring cable <input type="checkbox"/> Tip commander (A 1401)
Auto sequences (MI 3100 SE only)	<ul style="list-style-type: none"> <input type="checkbox"/> Test lead, 3 x 1.5 m <input type="checkbox"/> Mains measuring cable <input type="checkbox"/> Tip commander (A 1401)

Appendix C – Commander (A 1401)

Note:

- Commander A 1401 is applicable on MI 3100 SE only.

C.1 Warnings related to safety

Measuring category of commanders

Tip commander A 1401

(cap off, 18 mm tip)..... 1000 V CAT II / 600 V CAT II / 300 V CAT II

(cap on, 4 mm tip)..... 1000 V CAT II / 600 V CAT III / 300 V CAT IV

- Measuring category of commander can be lower than protection category of the instrument.
- If dangerous voltage is detected on the tested PE terminal, immediately stop all measurements, find and remove the fault!
- When replacing battery cells or before opening the battery compartment cover, disconnect the measuring accessory from the instrument and installation.
- Service, repairs or adjustment of instruments and accessories is only allowed to be carried out by a competent authorized personnel!

C.2 Battery

The commander uses two AAA size alkaline or rechargeable Ni-MH battery cells. Nominal operating time is at least 40 h and is declared for cells with nominal capacity of 850 mAh.

Notes:

- If the commander is not used for a long period of time, remove all batteries from the battery compartment.
- Alkaline or rechargeable Ni-MH batteries (size AA) can be used. Metrel recommends only using rechargeable batteries with a capacity of 800 mAh or above.
- Ensure that the battery cells are inserted correctly otherwise the commander will not operate and the batteries could be discharged.

C.3 Description of commanders

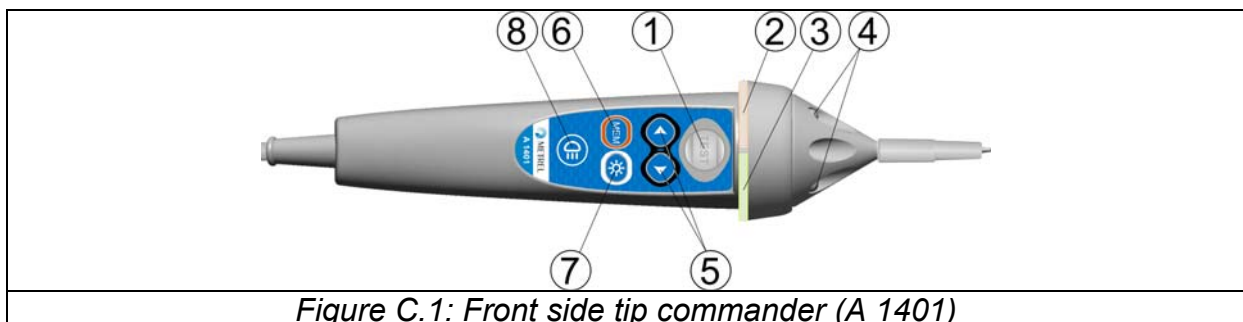

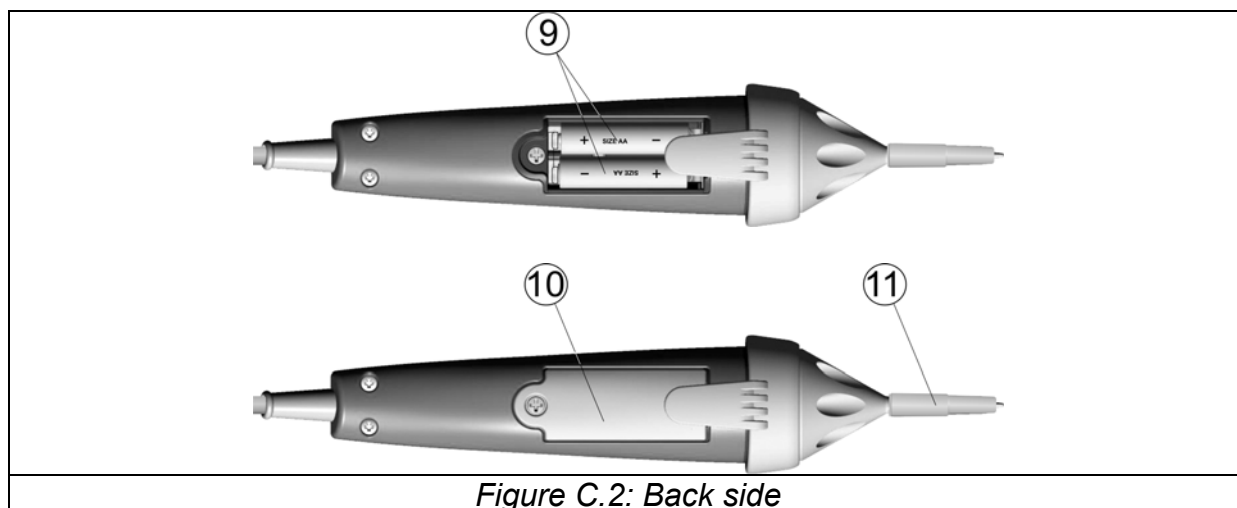

Figure C.2: Back side

Legend:

1	TEST	TEST	Starts measurements. Acts also as the PE touching electrode.
2	LED	Left status	RGB LED
3	LED	Right status	RGB LED
4	LEDs	Lamp	LEDs (Tip commander)
5	Function selector		Selects test function.
6	MEM		Store / recall / clear tests in memory of instrument.
7	BL		Switches On / Off backlight on instrument
8	Lamp key		Switches On / Off lamp (Tip commander)
9	Battery cells		Size AAA, alkaline / rechargeable NiMH
10	Battery cover		Battery compartment cover
11	Cap		Removable CAT IV cap (Tip commander)

C.4 Operation of commander

Both LED yellow	Warning! Dangerous voltage on the commander's PE terminal!
Right LED red	Fail indication
Right LED green	Pass indication
Left LED blinks blue	Commander is monitoring the input voltage
Left LED orange	Voltage between any test terminals is higher than 50 V
Both LEDs blink red	Low battery
Both LEDs red and switch off	Battery voltage too low for operation of commander

PE terminal test procedure

- ❑ **Connect** commander to the instrument.
- ❑ **Connect** commander to the item to be tested (see figure C.3).

- Touch PE test probe (the **TEST** key) on commander for at least one second.
- If PE terminal is connected to phase voltage both LEDs will light yellow, the warning message on the instrument is displayed, instrument's buzzer is activated, and further measurements are disabled in Zloop and RCD functions.

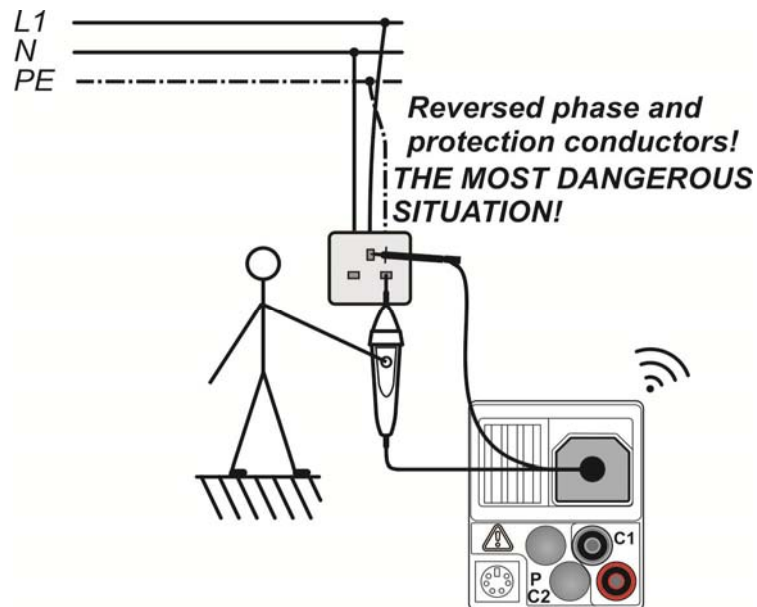

Figure C.3: Reversed L and PE conductors (application of tip commander)

