

Megger[®]

MFT1700 series

Multifunction testers

User manual

Contents

	SAFETY WARNINGS	3
1.	Introduction.....	4
2.	Overview	4
2.1	Front panel and controls	6
2.2	Waste electrical and electronic equipment.....	6
2.3	Battery and fuse location, fitting and replacement	6
3.	Operation	7
3.1	General operation – all models.....	7
3.2	Mode button functions.....	7
3.3	Test inhibit	7
4.	Voltage, frequency, current and temperature measurement.....	8
4.1	Making a voltage measurement	8
5.	Continuity / resistance measurement.....	10
5.1	Nulling test lead resistance (up to 9.99 ohms)	10
5.2	Making a CONTINUITY measurement.....	11
5.3	Storing / downloading results (MFT1731 only).....	11
5.4	Continuity Buzzer ON/OFF.....	11
5.5	Switch probe (SP5).....	11
5.6	Buzzer threshold	12
5.7	Measurement methods and sources of error	12
6.	Insulation resistance	12
6.1	Making an INSULATION measurement.....	12
6.2	Insulation test lock	13
6.3	Measurement methods and sources of error	13
7.	Loop Impedance testing.....	13
7.1	Range selection and test leads	14
7.2	Making a loop impedance measurement.....	15
7.3	Phase to Neutral (or Phase to Phase) testing.....	19
7.4	Prospective Fault Current and Short Circuit calculation (PFC & PSCC)	20
7.5	Zmax test mode	20
7.6	Making a Zmax loop impedance measurement	20
7.7	Making an R1+R2 loop impedance measurement (MFT1721 only).....	21
7.8	Measurement methods and sources of error	22
8.	Residual Current Device testing.....	22
8.1	Making an RCD measurement	23
8.2	Selecting RCD type	23
8.3	½ x I RCD current rating (No-trip test)	23
8.4	1 x I RCD current rating (Tripping test on 30mA RCD)	24
8.5	5 x I RCD current rating (Tripping test on 30mA RCD)	25
8.6	Ramp Test.....	25
8.7	Type A (DC sensitive) RCD test	26
8.8	Type B (Pure DC) RCD test.....	26
8.9	Variable RCDs (not MFT1711)	27
8.10	AUTO RCD testing	27
8.11	3 Phase RCD testing.....	27
8.12	Touch voltage display	29
8.13	Measurement methods and sources of error	29
8.14	Useful information.....	29
9.	Earth resistance measurement.....	29
9.1	Connection terminals.....	29
9.2	Touch voltage limit.....	29
9.4	Making a measurement – Three terminal resistance measurement	30
9.5		
9.6		
10.	Setup options	31
11.	Warning messages.....	32
11.1	Startup warnings	32
11.2	Battery.....	32
11.3	Battery charger	32
11.4	Fuse warning	32
11.5	Invalid rotary switch setting.....	32
11.6	Continuity test.....	32
11.7	Insulation test.....	32
11.8	RCD Test.....	32
11.9	RCD range selection errors.....	32
11.10	Loop Test.....	32
11.11	Earth test.....	32
11.12	Test will not start	32

Appendix A – Sending, storing, deleting and recalling test results.....	33
Appendix B – Downloading data using Bluetooth@.....	35
Appendix C – Installation category definitions	36
Appendix D – Safe working practice.....	36
Appendix E – Cleaning and maintenance	37
Appendix F – Earth resistance testing – Basic principles	37
General specification.....	38
Repair and warranty.....	41

SAFETY WARNINGS

Safety warnings and precautions **must** be read and understood before the instrument is used. They **must** be observed during use.

- The circuit under test **must** be switched off, de-energised and isolated before test connections are made when carrying out insulation and continuity tests.
- Continuity of protective conductors and earthed equipotential bonding of new or modified installations **must** be verified before carrying out an earth fault loop impedance test, RCD or earth testing
- **Do not** touch circuit connections and exposed metalwork of an installation or equipment under test. Under fault conditions the system earth could become hazardous live.
- **Do not** touch the earth stakes, test leads and their terminations (including connections to the earthing system under test) if an installation earth fault can arise, unless adequate precautions are taken.
- The 'live circuit warning' and 'automatic discharge' functions are additional safety features and **should not** be regarded as a substitute for normal safe working practices.
- **Do not** move the rotary switch positions while a test is in progress.
- **Do not** operate the instrument or connect it to any external system if it shows any visible signs of damage or if it has been stored for prolonged periods in unfavourable conditions.
- **Do not** operate the instrument or connect it to any external system if the battery compartment or casing is open or any parts of the case (including keypad, selector switch, display window, etc.) are missing.
- **Always** disconnect the instrument from all systems while batteries are being changed or the fuse replaced
- **Do not** replace rechargeable cells in the instrument with non-rechargeable "dry" cells and attempt to charge the cells. **This can cause explosion or fire.**
- **Do not** operate charging equipment supplied with the instrument in damp or wet environments or outdoors. All test leads **must** be removed from the instrument while charging.
- After insulation tests, capacitive circuits **must** be allowed to discharge before disconnecting test leads. Locking the insulation test ON **should only** be used where there is no risk of a circuit holding a charge.
- The instrument **should not** be used if any part of it is damaged.
- Test leads, probes and crocodile clips must be in good order, clean and with no broken or cracked insulation.
- All test leads supplied with the instrument form part of the measuring circuit of the instrument. They **must not** be modified or changed in any way, or be used with any other electrical instrument or appliance.
- A plug severed from the power cord **MUST** be destroyed, as a plug with bare conductors is hazardous in a live socket outlet.
- Ensure that hands remain behind guards of probes/clips when testing.
- U.K. Safety Authorities recommend the use of fused test leads when measuring voltage on high energy systems.
- Replacement fuses **must** be of the correct type and rating.
- Failure to fit the correctly rated fuse will result in damage to the instrument in the event of an overload.
- Special precautions are necessary when operating in situations where "live" earths may be encountered: isolation switches and fuses (not supplied with this instrument) must be used.
- Special precautions are necessary when working near high tension systems (MV and HV): rubber gloves and shoes (not supplied with this instrument) **should** be worn.
- Special precautions are necessary when working in wet conditions or in agricultural areas: observe the local safety standards and take all necessary special precautions applicable to the particular location and **do not touch** the test leads with bare hands.

LIVE EARTH SAFETY PRECAUTIONS

A 'Live' earth is one that carries current from the mains supply, or could do so under fault conditions. The following warnings apply in addition to those listed previously.

- All persons involved **must** be trained and competent in isolation and safety procedures for the system to be worked on. They **must** be clearly instructed not to touch the earth electrode, test stakes, test leads, or their terminations if any 'Live' earths may be encountered. It is recommended that they wear appropriate rubber gloves, rubber soled shoes, and stand on a rubber mat.
- The earth electrode under test should be isolated from the circuit it is protecting before testing commences. If this is not possible, ART (attached Rod Technique) may be used to measure electrode resistance.
- The instrument terminals **should** be connected to the system under test through isolation switches that are rated to handle the likely maximum fault voltages and currents that could be encountered at the installation. The isolation switch **must** be open whilst any personal contact is made with the remote test stakes, or the connecting leads, e.g. when changing their position.
- The instrument terminals **should** be connected to the system under test through fuses that are rated to handle the likely maximum fault voltages and currents that could be encountered at the installation.

NOTE

THE INSTRUMENT MUST ONLY BE USED BY SUITABLY TRAINED AND COMPETENT PERSONS

Users of this equipment and/or their employers are reminded that Health and Safety Legislation requires them to carry out valid risk assessments of all electrical work so as to identify potential sources of electrical danger and risk of electrical injury such as inadvertent short circuits. Where the assessments show that the risk is significant then the use of fused test leads constructed in accordance with the HSE guidance not GS38 'Electrical Test Equipment for use by Electricians' should be used .

This instrument is internally protected against electrical damage when used for the purposes of testing low voltage electrical installations as defined herein. If used in a manor other than those defined in this user guide, the protection capabilities could be impaired with potential risk to the operator and the instrument.

Symbols used on the instrument are:



Caution: Refer to accompanying notes



Maximum 300 V a.c. CAT IV to earth



Maximum nominal system voltage of 600 V



Instrument protected by 2 x F2 1000 V 30 kA fuses



Equipment complies with current EU Directives



This equipment should be recycled as electronic waste



Equipment complies with 'C tick' requirements

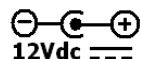

12 V DC charger socket

1. Introduction

Congratulations on your purchase of a genuine Megger Multifunction tester. The MFT1700 series Multi-function tester is a compact instrument designed to perform all of the functions required by the electrical contractor to fully test domestic, commercial and industrial wiring. Specially designed to comply with U.K., European and other International wiring regulations and standards, the MFT1700 may be used on all single and three phase systems with rated voltages up to 300 V AC. rms to earth (ground).

2. Overview

2.1 Front panel and controls

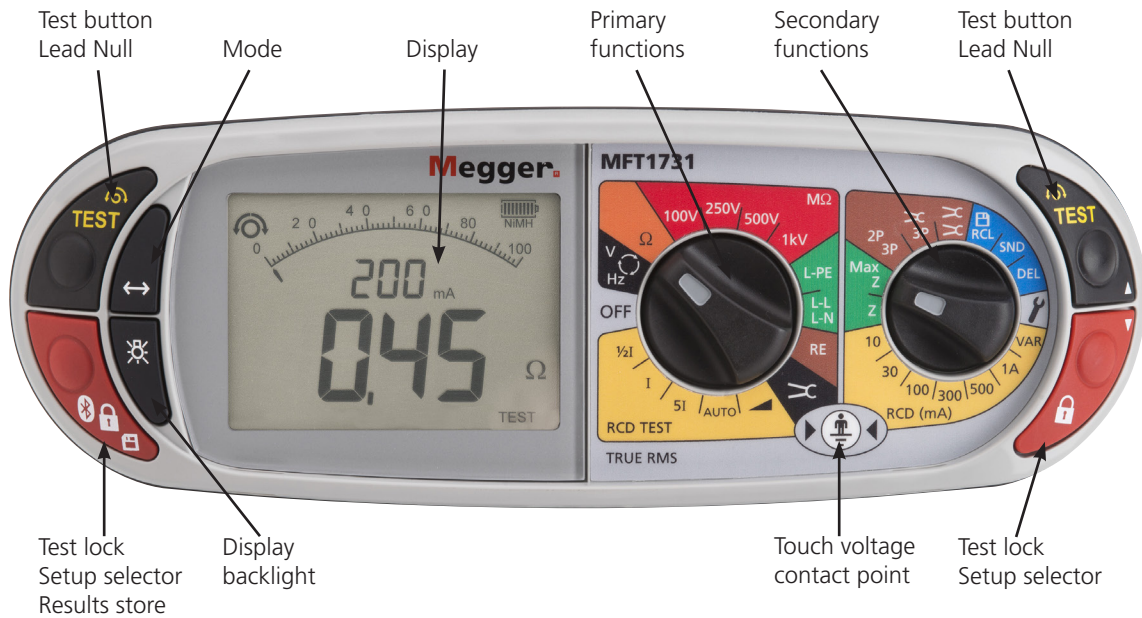



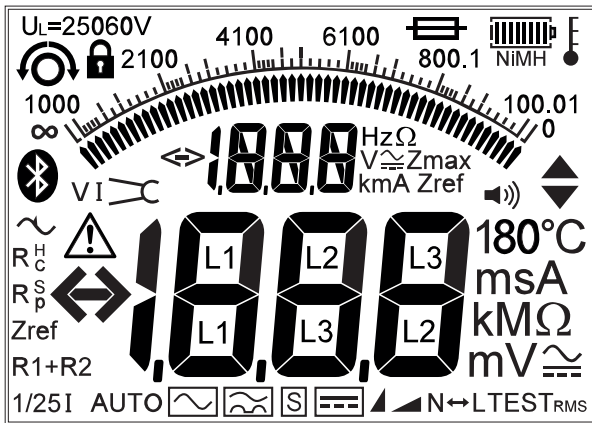















2.1.1 Display



NOTE: Some features detailed within this user guide are model dependent. Not all features appear on all models

Display symbols

Symbol	Meaning	Symbol	Meaning
	Test function locked on (also used to indicate a change is saved in setup)		Warning triangle – instruction to refer to this user guide
	Test lead null active		Fuse blown
U_L = 50V	Touch voltage limit (and Earth test voltage) set to 50 V (change setup)		Battery indicator
	Buzzer enabled	NiMH	Battery type set to rechargeable NiMH - Change in setup section 10
AUTO	RCD test in AUTO mode	>100 V	Indicates that the ground noise voltage exceeds the instrument measurement capability (test is inhibited)
	Type AC RCD selected	R_p (R_s)	Potential stake (P stake) resistance exceeds range for accurate measurement
	Type A RCD selected	R_c (R_H)	Current stake (C Stake) resistance exceeds range for accurate measurement
S 	Type S RCD (Type AC)	v 	Ground noise voltage exceeds range for accurate measurement of resistance
S 	Type S RCD (Type A)	V 	VCLAMP error
	Type B RCD selected	I 	ICLAMP error
	Fast or Full RAMP test selected		Bluetooth® enabled
TEST	Instrument is running a test		Instrument is too hot, allow to cool
	Earth loop noise detected.		
N<->L	Live and neutral connections reversed		
Zref	Reference loop measurement		
R1+R2	Loop measurement with Zref value automatically deducted		
ZMAX	Loop maximum measurement		

2.2 Waste electrical and electronic equipment

WEEE

 The crossed out wheeled bin placed on Megger products is a reminder not to dispose of the product at the end of its life with general waste.

 Megger is registered in the UK as a producer of electrical and electronic equipment. The Registration No is WEE/HE0146QT

2.3 Battery and fuse location, fitting and replacement

Battery type: 6 x 1.5 V Alkaline LR6 (AA) or NiMH HR6 rechargeable

Fuse type: 2 x F2 1000 V 30 kA fuses

Battery condition is shown by the following display symbols:

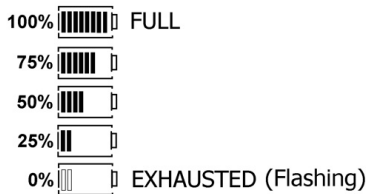

Where NiMH rechargeable batteries are fitted, the battery condition display can be adjusted accordingly. Refer to section 10 Setup options to change between alkaline and rechargeable batteries.

When set to NiMH batteries, the battery indicator in the display will show NiMH under the battery status symbol as below: (Feature available on all models).



To replace batteries or fuse:

Switch off the instrument.

Disconnect the instrument from any electrical circuits.

Remove the battery cover from the base.

For battery replacement:

- a) Remove old cells and refit new batteries following correct polarity as marked on the battery holder.
- c) Replace the battery cover.

Incorrect battery cell polarity can cause electrolyte leakage, resulting in damage to the instrument.

For fuse replacement

- a) Withdraw each fuse in turn and check for failure. The blown fuse must be replaced with a F2 1000 V 30 kA fuse.

Rechargeable batteries and battery charging

Some models are supplied with rechargeable NiMH cells. These batteries can be charged in the instrument, using the supplied Megger charger.

To charge the batteries:

Ensure fitted batteries are of the rechargeable NiMH type.

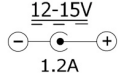
Connect the 12 V DC plug of the charger to the socket on the front of the MFT marked . The symbol shows a circle with a minus sign on the left, a plus sign on the right, and a central dot with the text '12-15V' above it and '1.2A' below it.

Warning: Whenever battery cells are being recharged, there should be no connections to the instrument terminals and the instrument should be switched off.

Warning: Do not attempt to recharge non-rechargeable (Primary) cells. Doing so may result in instrument damage and may cause personal injury.

Ensure ambient temperatures are between 4 °C and 40 °C while charging the MFT.

Note: The crossed out wheeled bin placed on the batteries is a reminder not to dispose of them with general waste at the end of their life.

Spent Alkaline and NiMH batteries are classified as portable batteries and should be disposed of in the UK in accordance with Local Authority requirements. For disposal of batteries in other parts of the EU contact your local distributor.

Megger is registered in the UK as a producer of batteries.

The Registration number is BPRN00142

3. Operation

3.1 General operation – all models

3.1.1 Switching on

Turn the rotary knob away from the off position.

The instrument will perform internal self tests then display the appropriate test screen, depending on the position of the function knobs.

3.1.2 Switching off

Turn the primary function knob to the OFF position.

The instrument will automatically turn itself off after 20 minutes* of inactivity. Press any button or turn either of the rotary knobs to turn back on.

* 2 minute option in Setup, refer to section 10.

3.1.3 Backlight

Press the backlight button.  The backlight will operate for 20 seconds.

3.1.4 Test buttons

Test buttons are duplicated on the left and right. Both buttons perform the same function except, when the  is displayed, in this case the right hand buttons perform a scrolling function. The left RED button also performs storage and lock functions on the MFT1731.

3.1.4 Test button lock

To lock the test button, hold down either of the RED test lock buttons with the  symbol, whilst holding down the test button. If  is displayed, the right hand buttons perform a scrolling function.

3.2 Mode button functions

The function of the mode button is dependent on the test function selected:

Test selected	Function	Options	Comments
V ^o C	Volts (mv model specific)		Temperature requires suitable transducer
Continuity RLO	Buzzer ENABLE/DISABLE	Buzzer ON Buzzer OFF	Buzzes on <2 Ω May be changed in SETUP. Refer to Section 10.
Insulation RSIO	Buzzer ENABLE/DISABLE	Buzzer ON Buzzer OFF	Buzzes on <1 MΩ May be changed in SETUP. Refer to Section 10.
Loop impedance (Z) L-PE	3Lo - 3 wire no trip 2Hi - 2 wire high current 2Lo - 2 wire no trip	3Lo 2Hi 2Lo	3Lo default measurement 2Lo not available if 3 wire connection is detected
RCD/GFCI	0° /180° selection	0° 180°	(Press and release)
	RCD Type	AC A AC(s) A(s) B	(Press and HOLD) Type B available on MFT1721 and MFT1731 only
EARTH (RE)	Touch voltage limit	50 V/ 25 V	(Press and release) MFT1731 only
SETUP	Refer to instrument setup section 10.		

3.3 Test inhibit

Each test mode has conditions under which testing will be inhibited, as below:

3.3.1 Insulation

Detection of a circuit voltage above 50 V (a warning is displayed at 25 V)

3.3.2 Continuity

Detection of a circuit voltage above that used by the instrument will inhibit testing

3.3.3 Earth loop impedance

Touch voltage exceeds 50 V (or 25 V depending on instrument configuration)

Supply voltage over range or under range

Supply frequency out of specification

3.3.4 RCD/GFCI testing

Touch voltage detected or predicted to exceed 50 V (or 25 V depending on instrument configuration)

Supply voltage over range or under range

Supply Frequency out of specification

3.3.5 Earth testing

External voltage greater than 25 V present

Leads not connected as per the test requirements

Potential stake not within range (Rp)

Current stake not within range (Rc)

Other conditions that will inhibit testing include:

3.3.6 Battery exhausted

All testing will be inhibited in the event of a flat battery, refer to section 2.3.

4. Voltage, frequency, current and temperature measurement

4.1 Making a voltage measurement

1. Set the Main rotary range knob to volts **V**
(The position of the right hand rotary range knob does not matter)

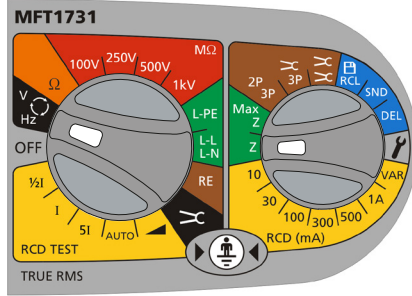

2. Using two test leads, connect test leads to the L1 (+ve) and L2 (-ve) terminals

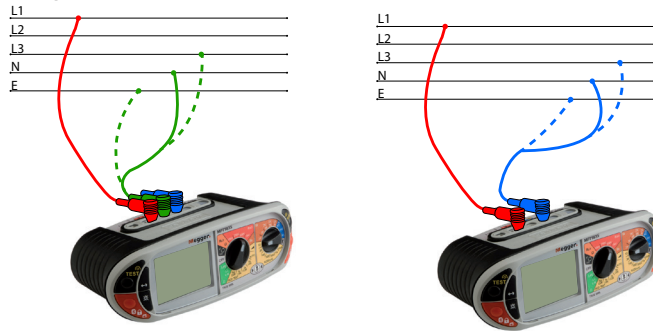

OR if Using the Mains plug Lead SAI10:

- a. For Live to Neutral measurements, connect the Red connector to the L1 terminal and the Blue connector to the L2 terminal
- b. For Live to Earth measurements connect the Red test to the L1 terminal and the Green connector to the L2 terminal

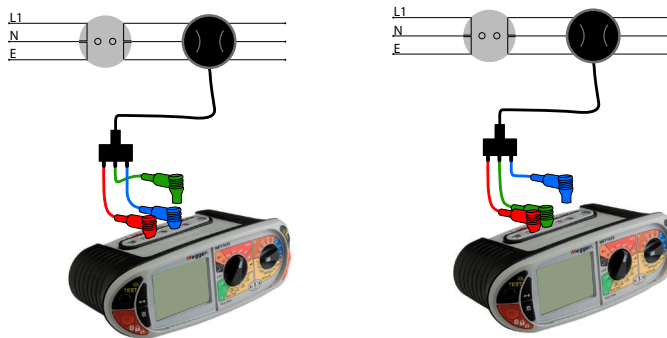

Connection (a)

Connection (b)

Note: When connecting all three test leads (eg Phase, Neutral and Earth) or the mains plug test lead, the voltage displayed is the highest of the three possible voltages.

Pressing either TEST button scrolls through L-E, N-E and L-N individual voltages. When the frequency of supply is shown, the voltage displayed reverts to the maximum voltage across all 3 terminals.

On models with a dedicated mV range this is selected using the Mode button to select mV mode.

4.2 Frequency measurement

1. Automatically displayed when connecting to a live circuit as per 4.1 above

4.3 Phase rotation (Not MFT1711)

Display of Phase rotation is Automatic when all three test leads are connected to the 3 phase supply as below:

1. Set the main rotary range knob to volts **V**
(The position of the right hand rotary range knob does not matter)

- Using three test leads, connect test leads to the L1 to Phase1, L2 to Phase 2 and L3 to Phase 3. The MFT will display L1 L2 L3 or L1 L3 L2 depending on the direction of phase rotation.

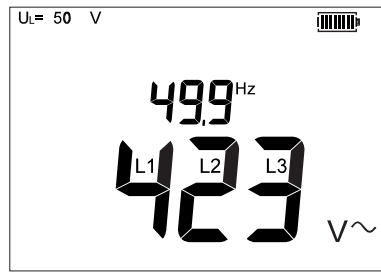
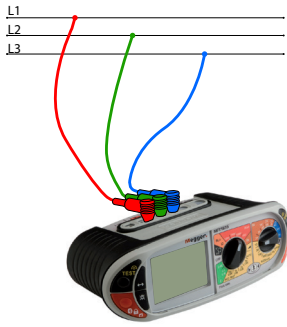

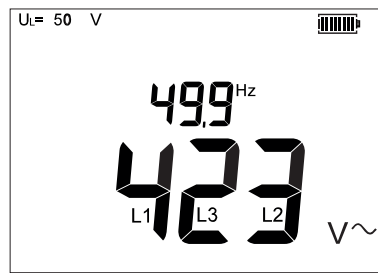

Normal rotation



Reverse rotation

4.4 Leakage current measurement

Leakage current measurement uses the optional accessory current clamp (ICLAMP).

- On the MFT1721, MFT1731, set the primary range knob to clamp position .
- Connect to ICLAMP (part no. ICLAMP) to the ICLAMP  socket on the MFT.
- Connect the clamp to the circuit conductor. The instrument will display the AC current flowing in the conductor.

4.5 Temperature measurement (not on MFT1711)

- Connect the thermocouple transducer to the L1 (+ve) and L2 (-ve) terminals
- Press the Mode  button to select °C. (Pressing the mode button will cycle round the V, mV and °C measurement modes)

The display will show the temperature at the tip of the temperature probe.

4.6 Switch probe

In the V/mV/°C mode all measurements except temperature can be made with the remote switch probe. Tests are automatic and do not require the test button to be pressed.

- Connect the switch probe to the switch probe socket. The probe replaces the standard RED test lead and can now be used as a normal test probe.

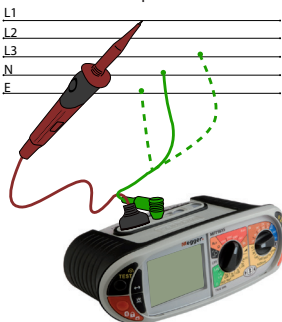

5. Continuity / resistance measurement

IMPORTANT

The continuity test will auto-range from 0.01 Ω to 99.9 k Ω . Circuits up to 2 Ω will be tested at >200 mA. To change the test current, go to section 10 - Setup.

The continuity test is automatic. The test starts as soon as the leads are connected to a circuit. The TEST button is ONLY used to null the lead set.

Warning: Prior to any continuity testing, ensure the circuits under test are isolated and not live.

SETUP allows the follow configuration options:

- Positive test current
- Bi-Directional test current

Bi-directional test current allows the automatic testing of the circuit in both directions and the highest measured value being displayed See section 10 Setup options.

5.1 Nulling test lead resistance (up to 9.99 ohms) Ω

Before starting a continuity test, the test lead resistance should be nulled such that it does not add extra resistance to the circuit being measured. Once nulled it does **not need** repeating for each test. Periodically it should be checked to ensure nothing has changed.

The "Lead Null" value is retained even when the tester is switched off.

To null test leads:

1. Short test probes or clips together and press the TEST button. The null symbol  will be displayed to indicate lead null is active.

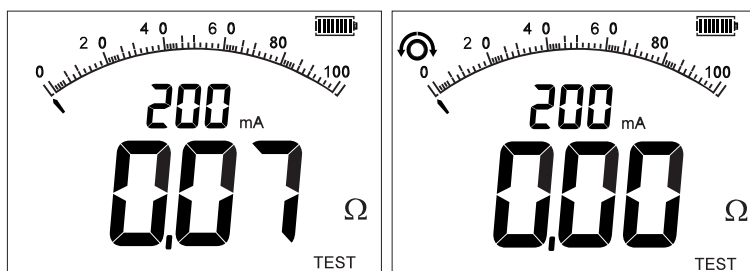
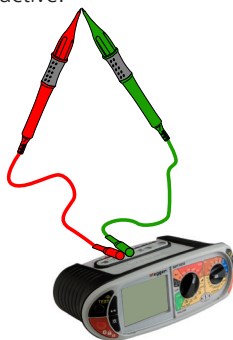

Lead null OFF

This null value is stored until the TEST button is pressed again.

2. To cancel the LEAD NULL, separate the test leads and press the TEST button.

5.2 Making a CONTINUITY measurement

1. Set the Primary (Left) range knob to Ω range. (The position of the right hand rotary range knob must not be in the  position).

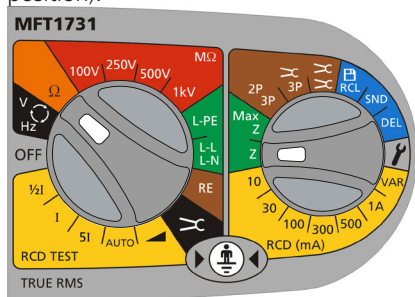

2. Connect two test leads to the L1 (+ve) and L2 (-ve) terminals on the instrument. A continuity measurement is made automatically.

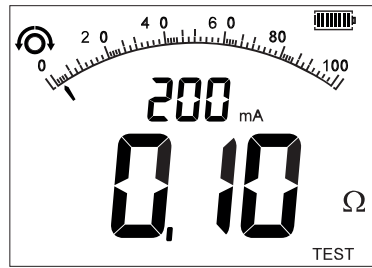
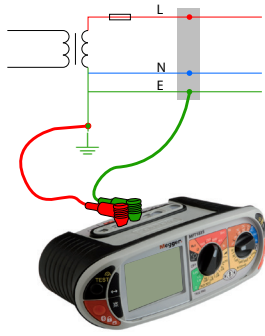

NOTES: Measurements are prevented when:
 A resistance of > 99.9 kΩ is present
 Circuit voltages in excess of 4 V are detected.

5.3 Storing / downloading results (Not MFT1711 or MFT1721)

For full details see Appendix A and B.

Once the display shows a value it will automatically be logged into temporary memory. Unless stored, this will be over written by the next measurement.

To store this result or to send it to a PowerSuite compatible device, refer to Appendix A and B.

5.4 Continuity Buzzer ON/OFF

Whilst in the continuity range, press the MODE button . This will toggle the buzzer ON and OFF.

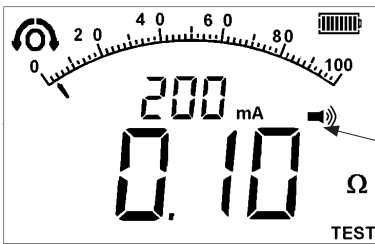

Buzzer ON = 
 Buzzer OFF = No symbol

5.5 Switch probe (SP5)

In the CONTINUITY/RESISTANCE mode all measurements can be made with the remote switch probe (SP5). Tests are automatic and do not require the TEST button to be pressed.

1. Connect the switch probe to the switch probe socket L1 (+ve). The switch probe replaces the standard RED test lead. Test as in 5.2 above.

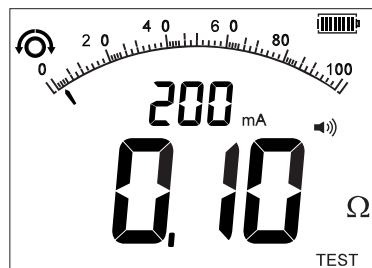
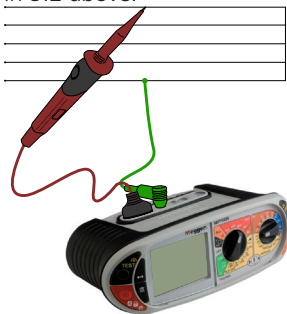

5.6 Buzzer threshold

If the measured resistance is less than the buzzer threshold, the buzzer will sound. The resistance at which the buzzer stops sounding can be changed to meet individual test requirements. Refer to the Setup section 10 of this guide.

Selectable limits of 0.5 Ω , 1 Ω , 2 Ω , 5 Ω , 10 Ω , 20 Ω , 50 Ω , 100 Ω , (depending on model) are available.

This setting is stored even when the instrument is switched off.

5.7 Measurement methods and sources of error

Method of measurement

The 2-wire lead set must be used for this measurement. A DC voltage of nominally 4.4 V with a current limit of >200 mA is used to measure resistance less than 2 Ω .

Possible sources of error

Measurement results can be affected by the following:

- The presence of circuits connected in parallel.
- Presence of AC voltages on the circuit being measured
- A poor connection to the circuit under test
- Incorrectly nulled test leads
- Use of fused leads

6. Insulation resistance 500 V

IMPORTANT:

The insulation test is protected by a live circuit warning. Detection of a voltage over 50 V will inhibit testing. This applies whether or not the insulation test is locked on.

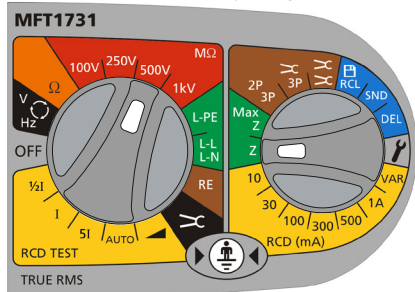

6.1 Making an INSULATION measurement

1. Set the left hand rotary range knob to the 500 V insulation test voltage required:

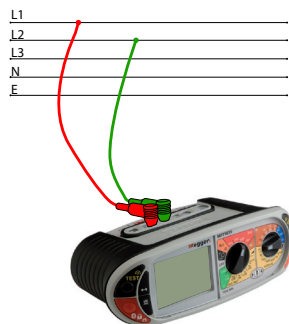

2. Connect two test leads to the L1 (+ve) and L2 (-ve) terminals on the instrument.



3. To start test, press and hold either of the TEST buttons,  or , on the instrument. Release the test button after the displayed reading has settled. The circuit will now discharge safely.

Note: A 1000 V warning is displayed whenever the 1000 V range is selected for the first time and the TEST button is pressed.

6.2 Insulation test lock

To lock an insulation test ON, hold down either of the TEST buttons followed by either of the RED LOCK buttons.

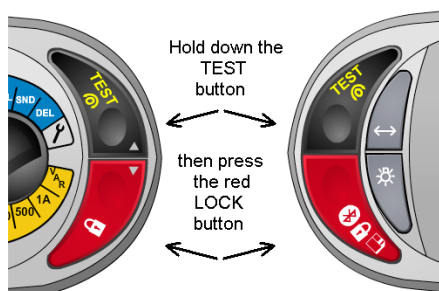

To release the "Locked on" insulation test, press the TEST button.

Warning: The test voltage will be permanently present on the test probes or crocodile clips when in the locked position.

Warning: Auto discharge - Auto discharge facility automatically and safely discharges the circuit at the completion of an insulation test.

Live circuit warning - operates when connected to Live circuits > 25 V. Testing is still permitted.

Test inhibited - Live circuits greater than 50 V will inhibit testing.

6.3 Measurement methods and sources of error

Method of measurement

The selected DC test voltage (current limited to less than 2 mA DC).is applied to the circuit under test and the resistance is calculated from measurements of the resulting voltage and current.

Capacitive circuits can take some time to charge. This is displayed as an increasing voltage that takes longer to reach its maximum than normal.

The reading is stable with a circuit capacitance less than 5 μF .

7. Loop impedance testing (Not MFT70)

IMPORTANT

This measurement requires both selector knobs to be set to the Loop testing mode (GREEN RANGES).

This is a live circuit test. All precautions relevant to working on live circuits, to ensure the safety of the operator and any other personnel should be in place.

Overview of the LOOP IMPEDANCE test

A Loop impedance test is the measurement of the impedance of a circuit whilst the circuit is electrically live.

Unlike a continuity test, a loop impedance test applies a load to the circuit and measures the change in the circuit voltage, from which the loop "resistance" is calculated.

For those circuits protected by an RCD the load that is connected Phase to Earth must be small enough not to trip the RCD. Consequently there must be many tests performed to establish the loop impedance of the circuit. These are automatically performed and the end result is displayed.

Test Lead Null:

The MFT does not need the resistance of the test leads to be nulled for this test. They are already calibrated into the measurement circuit at 0.07Ω .

However if using fused leads or 3rd party test leads, the resistance of these leads may be different. In this case they can be measured using the continuity test and the resistance can be compensated for in the Setup options, see section 10.

Circuit connection:

The MFT is designed to test the L-PE and the L-N (and L-L) part of the circuit. Selecting the L-PE range on the MFT will enable testing of the Live to Earth circuit as below:

7.1 Range selection and test leads

7.1.1 Phase to earth L-E circuits:

The main range knob and test leads should be connected as shown:

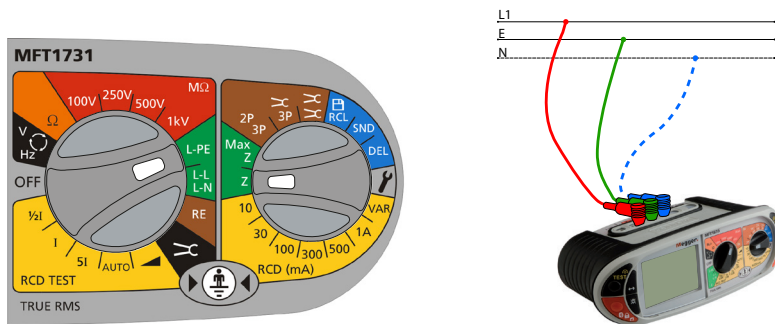

The right hand knob should be set to "Z"

Connecting the 3rd (Blue) lead enables the "3 wire loop test 3Lo, as above and "reverse polarity detection".

Test Options in L-PE mode:

In L-PE mode the MFT1700 series offer 3 types of loop test:

3Lo – A 3-wire low current loop impedance test. This test requires all three connections.

Where to use:

For making L-E measurements on circuits where all three conductors are available **AND** the Phase – Earth circuit is RCD protected. Requires all three test leads to be connected.

2Hi – A 2-wire high current test. A fast 3-4 second test using high test currents.

Where to use:

On ALL circuits except Phase – Earth measurements on RCD protected circuits.

2Lo – A 2-Wire low current loop test for L-E measurements where the 3rd conductor is not available.

Where to use:

On RCD protected circuits where access to all three conductors is not possible

Note: 2Lo is not available when all three leads are connected, as the 3Lo is the preferred measurement mode.

Selecting the test mode:

To switch between Loop test modes press the Function  button, as below:

Press the function key  to change between 3Lo, 2Hi & 2Lo



The test mode is displayed as below:

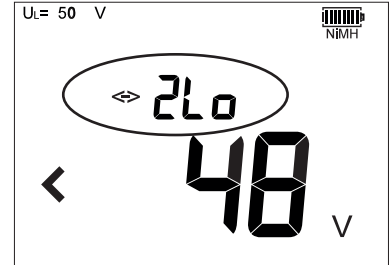
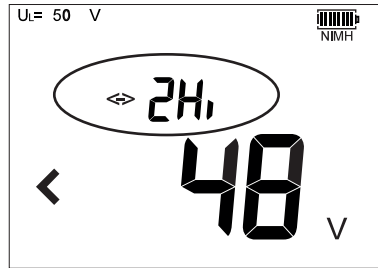
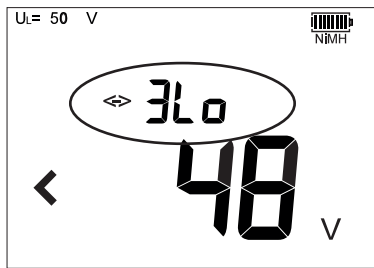

Default mode

1st Press

2nd Press

Note: RCDs can still trip when performing a “non-trip” loop test if there is an existing high level of fault current flowing in the Earth conductor, or the RCD is not operating within specification.

7.1.2 L-N or L-L circuits:

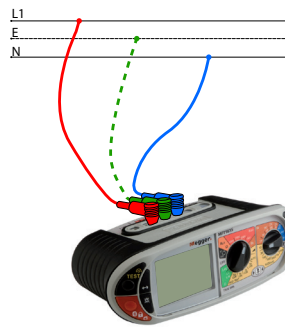
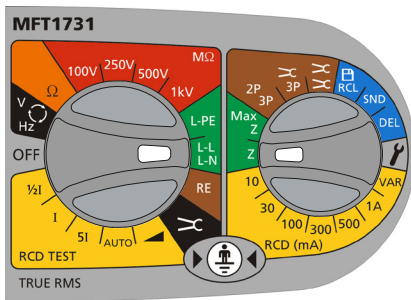

L-N (or L-L) selected

Test performed

7.1.3 Z, Z_{max}, Z_{ref} and R1+R2 (MFT1721)

The right range knob has additional options.

- Z - Standard loop impedance measurements
- Z_{max} - For multiple loop measurements where the worst case value is required
- Z_{ref} - the Z_e or Z_{db} value used when calculating the R1+R2 value
- R1+R2 - The loop impedance less the Z_{ref} value.

For general loop impedance testing the Z setting should be selected.

Refer to section 7.5 to 7.7 for additional functionality.

7.2 Making a loop impedance measurement

7.2.1 Z_e measurements at the origin (Phase to Earth)

1. Set the LEFT rotary range knob to the **L-PE** range.
2. Set the RIGHT rotary knob to **Z**.

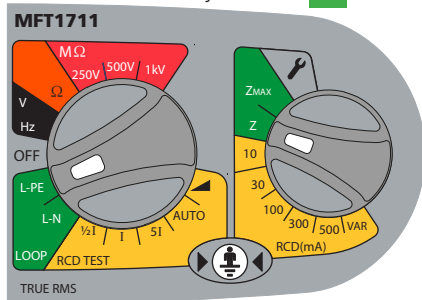

The MFT automatically uses the Phase and Earth terminals.

3. Connect test leads as below, with the Red test lead connected to the L1 (Red terminal on the MFT and the Green test lead connected to the Green (L2) terminal).

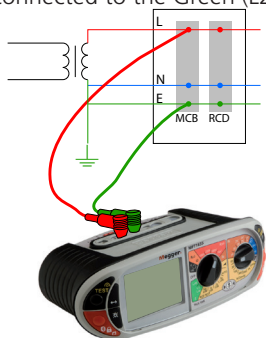

4. Press the Function key  to select the "2Hi" mode. The RCD will not trip, so there is no need to use the 3Lo and 2Lo modes.

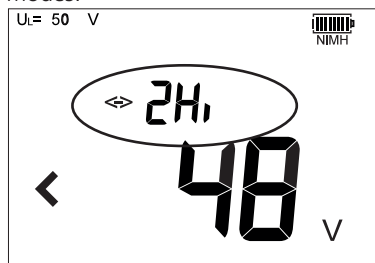

5. Press TEST to start the test sequence. This can be automated in SETUP so the test starts when contacting the circuit. See section 10 – Setup.
6. On completion of the test, the display will show the loop resistance on the large display segments, and the fault current on the small display segments.



Reverse Polarity warning:

The 3rd test lead can be connected to Neutral (L3) but is not used in the '2Hi' Phase-Earth measurement. However the MFT will show a Phase-Neutral reversed connection if present.

7.2.2 Z_s and Z_{db} loop measurements without RCD - eg Z_s , Z_{db} etc.

1. Set the LEFT rotary range knob to the **L-PE** range
2. Set the RIGHT rotary knob to **Z**.

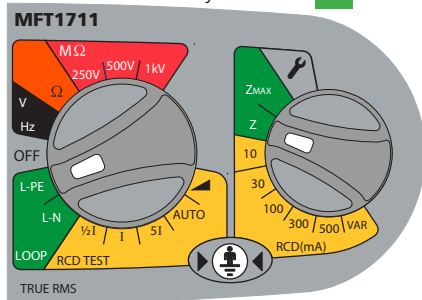

3. Connect test leads as below, with the Red test lead connected to the Red (L1) terminal on the MFT and the Green test lead connected to the Green (L2) terminal.

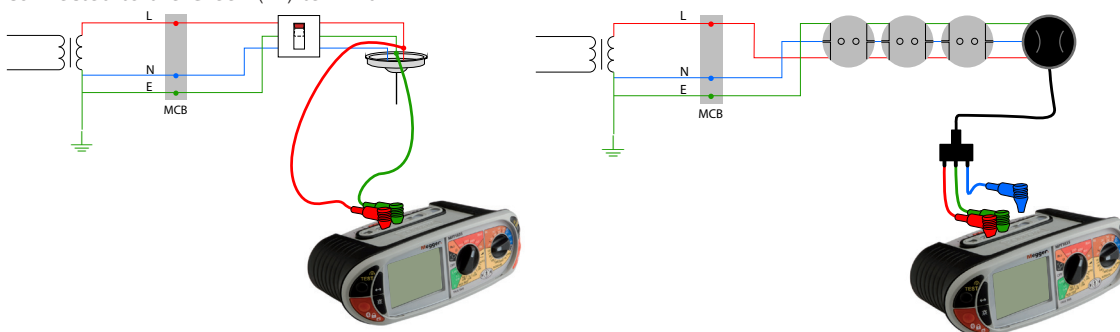

The Blue (L3) test lead can be connected to enable "reverse polarity" warnings

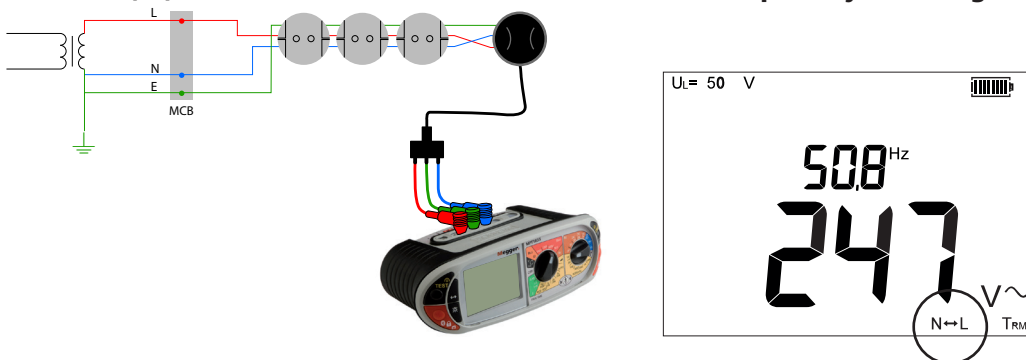

4. Press the Function key  to select the "2Hi" mode.

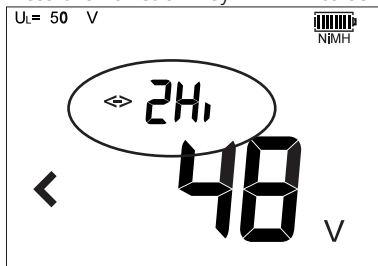

5. Press 'TEST' to start the test sequence. This can be automated in SETUP so the test starts when contacting the circuit. See section 10 Setup.
6. On completion of the test, the display will show the loop resistance on the large display segments, and the fault current on the small display segments.

7.2.3 Earth Loop measurements with an RCD in circuit

Loop testing L-N through and RCD will not trip it, using the 2Hi test mode. However testing Phase to Earth requires a test that draws less current to help prevent the RCD tripping. It is impossible to guarantee that an RCD will not trip. If there is a risk associated with tripping an RCD alternative methods should be used for testing the circuit.

Using 3 wire measurement - 3Lo

1. Set the LEFT rotary range knob to the **L-PE** range.
2. Set the RIGHT rotary knob to **Z**.

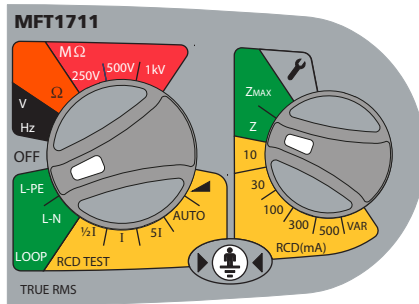

3. Connect test leads as below, with the Red test lead connected to the Red (L1) terminal on the MFT, the Green test lead connected to the Green (L2) terminal and the Blue test lead to the Blue (L3) terminal.

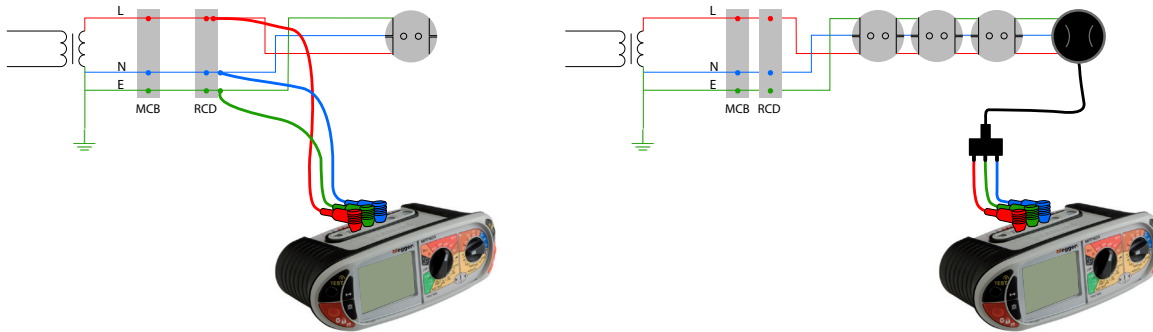

4. Ensure the display is in the "3Lo" mode. If not, press the  function button to select "3Lo".

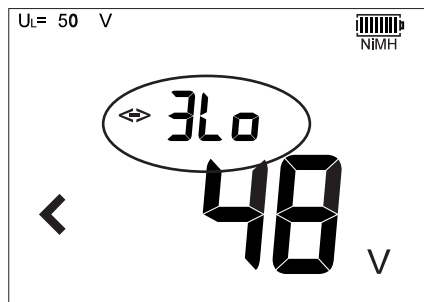

5. Press 'TEST' to start the test sequence. This can be automated in Setup so the test starts when contacting the circuit. See section 10.
6. On completion of the test, the display will show the loop resistance on the large display segments, and the fault current on the small display segments.

Using 2 wire measurement - 2Lo

1. Set the LEFT rotary range knob to the **L-PE** range.
2. Set the RIGHT rotary knob to **Z**.

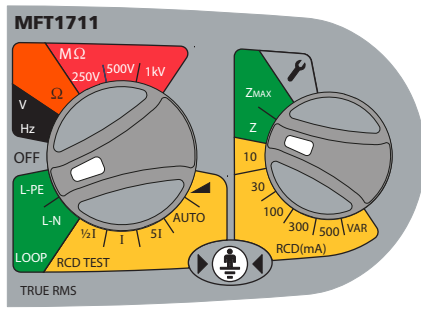

3. Connect the test leads to the circuit as below, with the Red test lead connected to the Red (L1) terminal on the MFT and the Green test lead to the Green (L2) terminal.

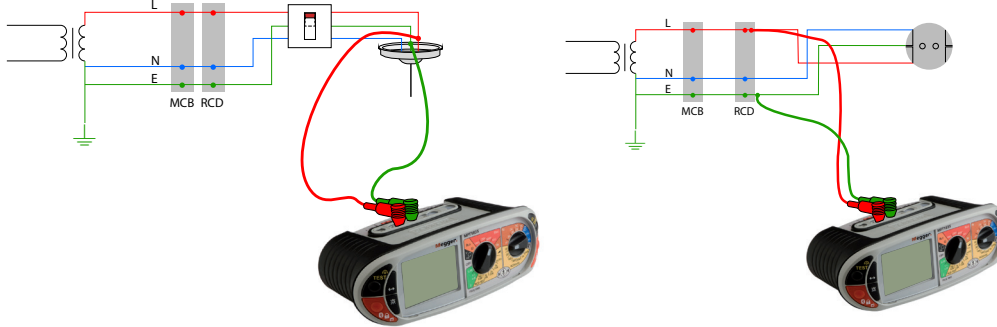

4. Press the Function key to select the "2Lo" mode.

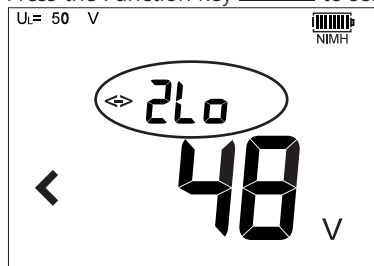

5. Press TEST to start the test sequence.
6. On completion of the test, the display will show the loop resistance on the large display segments, and the fault current on the small display segments.

7.3 Phase to Neutral (all models) or Phase to Phase (not MFT1711) testing

Note: Only the "2Hi" mode is available on this range.

1. Set the LEFT rotary range knob to the range.
2. Set the RIGHT rotary knob to .

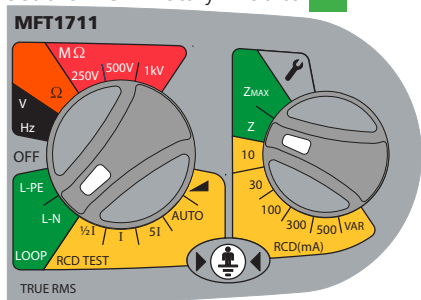

MFT1711

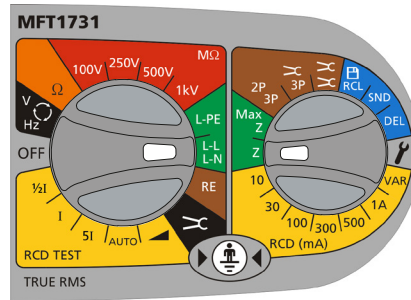

MFT1731

3. Connect the test leads to the circuit as below, with the Red test lead connected to the Red (L1) Red terminal on the MFT and the Blue test lead to the Blue (L3) terminal.

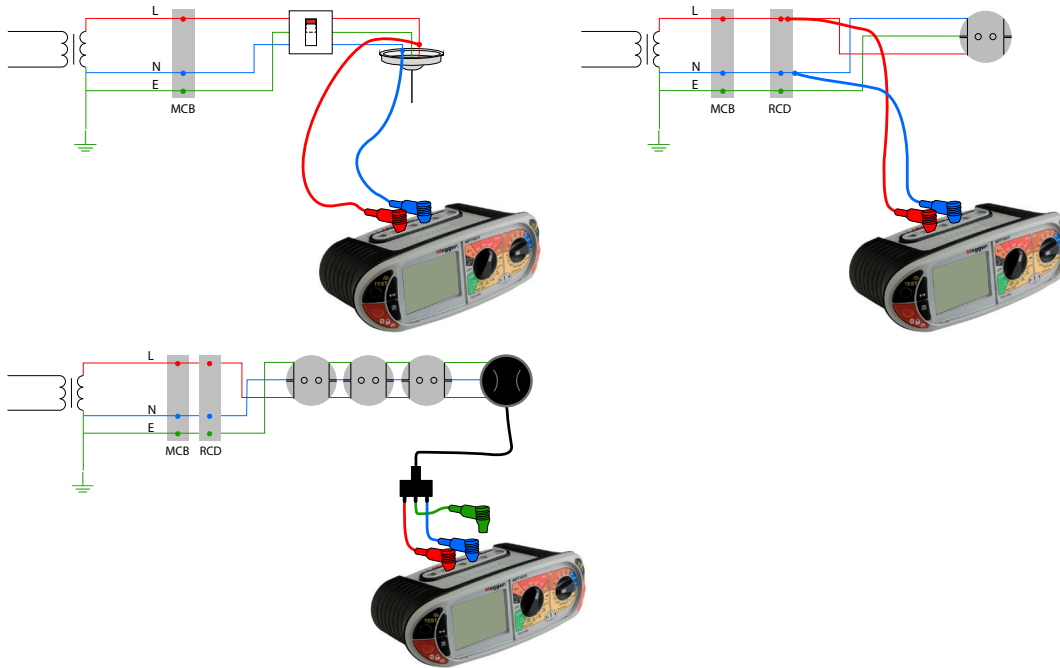

4. Press and release the TEST button to start the test.
5. On completion of the test, the display will show the loop resistance on the large display segments, and the fault current on the small display segments.

7.4 Prospective Fault Current and Short Circuit calculation (PFC & PSCC)

The prospective fault current and short circuit current of a circuit is automatically calculated when making a loop impedance test. The calculation uses a nominal circuit voltage, not the actual circuit voltage, and is displayed above the loop impedance measurement, as below:

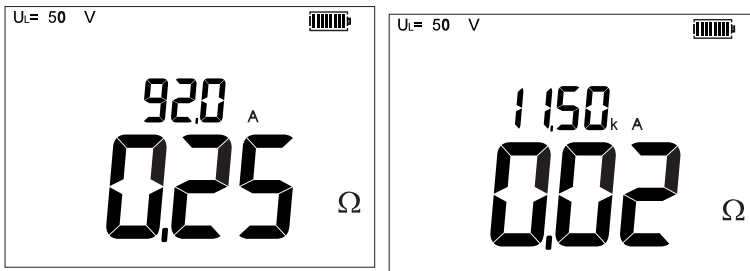

The fault current is calculated using the expression:-

$$\text{PSCC or PFC} = \frac{\text{Nominal supply voltage in Volts}}{\text{Loop resistance in Ohms}}$$

$$\begin{aligned} \text{Example PSCC or PFC} &= 230 \text{ V} / 0.13 \Omega \\ &= 1769 \text{ VA (displayed on the MFT as 1.77 kA)} \end{aligned}$$

The nominal supply voltage used in the calculation is automatically selected depending on the actual circuit voltage. The instrument uses the following voltage values:-

Actual measured voltage	Nominal voltage
< 75 V	55 V
≥ 75 V and <150 V	110 V
≥ 150 V and <300 V	230 V
≥300 V	400 V

7.5 Z_{max} test mode

Ideal for multiple loop measurements on a ring final circuit where the highest loop value is to be recorded.

Both **L-PE** and **L-N** test options can be used.

The current loop test value is displayed on the lower (larger) readout, whilst the maximum measured value of the sequence is displayed on the upper (smaller) readout.

7.6 Making a Z_{max} loop impedance measurement

1. Set the LEFT rotary range knob to the $L-PE$ or $L-N$ range
2. Set the RIGHT rotary knob to $Max Z$

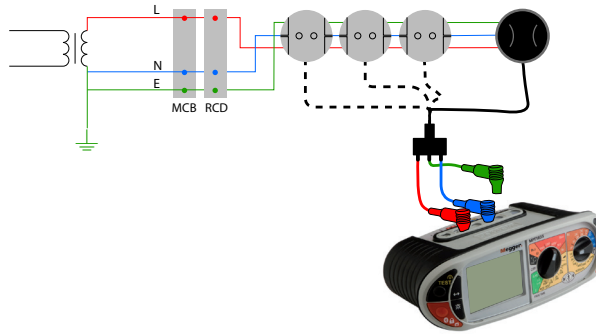
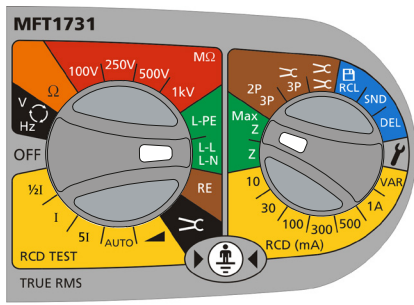

3. Connect the test leads to the Phase (L1) and Earth (L2) or Phase (L1) and Neutral (L3) terminals on the tester depending on the selection in (.1) above.
4. Connect the test leads to the Phase and Earth conductors or Phase and Neutral conductors as required. If using the mains plug test lead connect to the first supply outlet.
5. Press the TEST button. The loop impedance will be displayed in the large readout and the small readout.

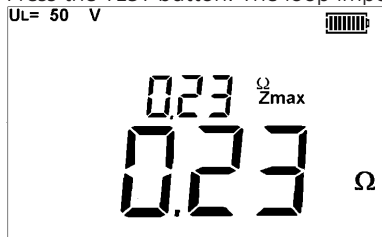

6. Move to the 2nd socket to be tested and make another loop test. If the result is less than the first the large readout will show the new value but the small readout will remain unchanged. If the new value is higher, the small readout will be updated accordingly, as below:

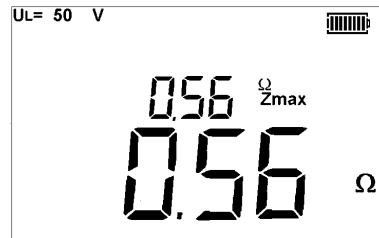
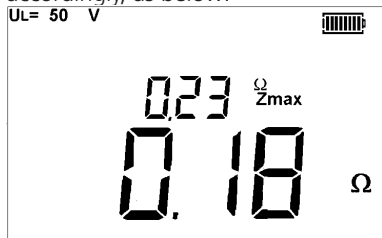

2nd result lower than 1st result

2nd result higher than first result

7. Repeat the loop impedance test at each of the remaining sockets. At the conclusion of testing simply read off the Z_{max} value from the upper display readout.

This value is retained until the instrument is switched off (or automatically switches off)

7.7 Making an $R1+R2$ Loop impedance measurement (MFT1721 only)

The $R1+R2$ mode requires a reference measurement to be made, typically Z_e or Z_{db} . This is then automatically subtracted from the circuit loop impedance when measurements are made in the $R1+R2$ mode.

1. Set the RIGHT rotary range knob to the Z_{ref} range.

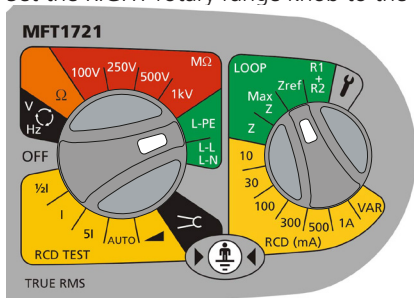

2. Make a loop measurement using either the Phase to Neutral or Phase to Earth methods above. This value is automatically stored as the reference value. This can be repeated if necessary.

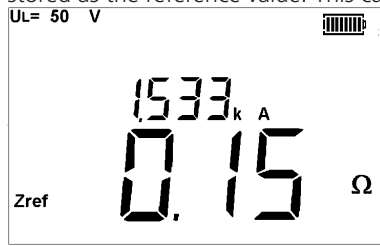

3. Switch the range knob to $\frac{R1}{R2}$ and make loop impedance tests as previously.

The main readout will show the R1+R2 value (eg. Zs - Zref)

The small readout will show the Zref value.



7.8 Measurement methods and sources of error

Method of measurement

During a loop test the instrument measures the difference between the unloaded and loaded supply voltages. From this difference it is possible to calculate the loop resistance. The test current will vary from 15 mA to 5 A, depending on supply voltage and the loop resistance value. The volt drop from a 15 mA load is exceptionally small, consequently the instrument performs many measurements automatically. This test takes a long time to complete, typically 20 seconds

Possible sources of error

The reading depends on the stability of the supply voltage during the test. Therefore noise, harmonics or transients, caused by other equipment during the test could cause an error in the reading. The instrument will detect some sources of noise and warn the user.

It is recommended that more than one test is performed on the circuit to ensure the measured value is repeatable, especially when performing a 3Lo measurement.

Capacitive loads across the Phase-Earth circuit can affect the accuracy of the Non-trip loop test. For this reason the P-E (non-trip) loop test should not be used on the P-N circuits.

Errors can be reduced by:-

- Use the two-wire lead set with prods and making a firm connection to clean conductors.
- Make several tests and take the average.
- Ensure that potential sources of noise in the installation are isolated (switched off), eg: automatically switched loads or motor controllers

8. Residual Current Device (RCD) or Ground Fault Current Interrupt (GFCI) testing

NOTE: The MFT1700 series can perform the following RCD tests:

- 1/2I** Non-tripping test at half the rated RCD trip current for 2 seconds, during which the RCD should not trip
- I** Tripping test at the rated RCD trip current. The trip time will be displayed
- 5I** Tripping test at 5 x the rated RCD trip current. The trip time will be displayed in milliseconds.
- 0 or 180°** Some RCDs are sensitive to the polarity of the supply, i.e whether the test current is applied with the instantaneous rising or falling. Tests should therefore be performed with the polarity 0° and 180° and the maximum time recorded.
- RampTest** Used to check the trip current of an RCD.





The MFT1700 series can test the following RCD types:

AS, A, S, and Programmable (typically a type A RCD with variable disconnection time)

The MFT1721 and MFT1731 can also test Type B RCDs.

RCD's are also available with a Selective (Delayed) trip time. These are referred to as Type S. These RCDs do not trip instantly, allowing ordinary type RCDs to trip first.

The characteristics of each RCD type is detailed below:

RCD Type	AC	A	S	B
Description	Operate with AC residual earth currents only.	Operate with AC and pulsed DC residual earth currents.	Selective RCD Operates on type AC with time delay or type A with time delay	Operate with AC Pulsed DC and Smooth DC residual earth currents
Symbol used				
Application	General purpose protection of Sinusoidal AC supplies.	Protects against AC and pulsed DC (rectified AC).	For use upstream of a standard AC RCD to prevent trip contention. ie. Allows local trip to operate first. TIP: Remember "S" for "Slow tripping"	Special applications where protection of DC, as well as AC earth faults may be encountered. Other types will not operate on DC fault currents.
Trip times	Trip times as defined in BS EN			
½ I	>300 ms (>1999 ms UK) No trip	>300 ms (>1999 ms UK) No trip	300 ms (>1999 ms UK) No trip	>300 ms (>1999 ms UK) No trip
1 x I	≤300 ms	≤300 ms	130 ms to 500 ms	≤300 ms
5 x I	≤40 ms (30 mA RCD's only)	≤40 ms (30 mA RCD's only)	≤40 ms <150 ms (30 mA RCD's only)	≤40 ms <150 ms (30 mA RCD's only)

8.1 Making an RCD measurement

NOTES:

- To select 0° or 180° press and release the mode button  whilst in RCD test mode
- 10 mA and 30 mA RCD's should be tested at ½ x I, 1 x I and 5 x I
- All other RCDs only need to be tested at 1 x I
- I = trip current rating of the RCD
- Connecting the neutral test lead in either of the above options will not affect the RCD but will detect a reverse polarity and, the testing will be inhibited.

NOTE: The MFT70 can perform a ramp test on a GFCI to ensure it trips under fault conditions as in 8.6. No other RCD/GFCI tests are available on the MFT70

8.2 Selecting RCD type

Using the right hand (secondary range knob) select the RCD trip rating. This is printed on the RCD (10 mA, 30 mA 100 mA etc)



Select the RCD type, either AC, A, S or B by pressing and HOLDING DOWN the mode button  for 2 seconds whilst in RCD test mode. Repeat until the RCD type is displayed. Refer to table above for symbol options and descriptions.

Note: Type B RCD testing is NOT available on MFT1711.

8.3 1/2 x I RCD current rating (No-trip test)

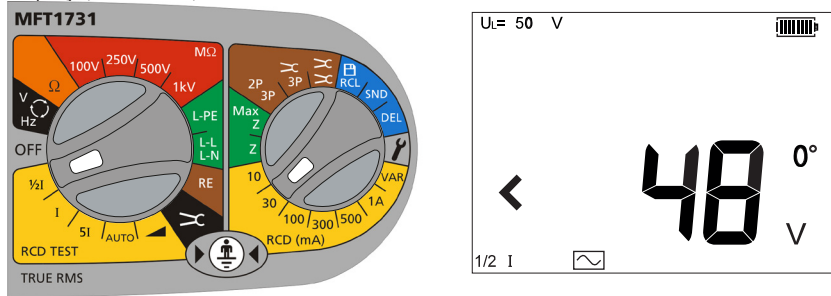
1. Set the LEFT rotary range knob to the **1/2 I** RCD test range.
2. Set the RIGHT rotary range knob to current rating of the RCD under test **30** = 30 mA etc. Ensure the display shows 0° in the display (see below):



3. Connect the instrument Phase (L1) and Earth (L2) terminals to the RCD phase and Earth terminals (or to the phase and earth of the circuit the RCD is protecting). Use either the separate leads  or mains plug  leads.

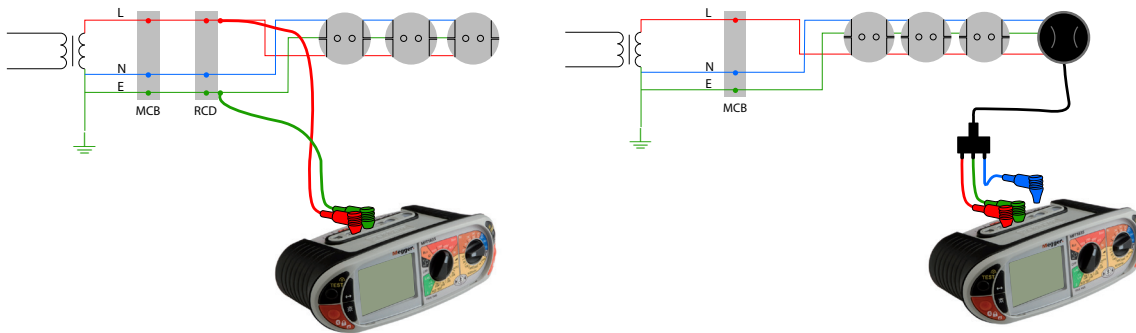

4. Press the TEST button. The Display should show one of the following:

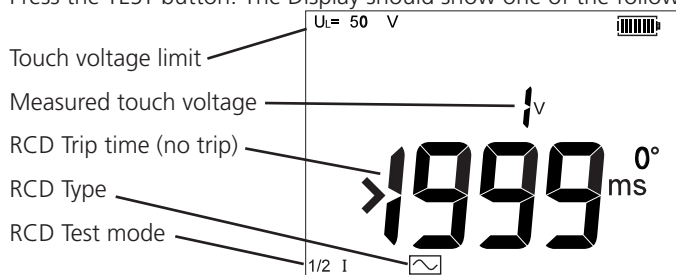

If the RCD Trips, the MFT will flash the "trP" warning and then display the following:

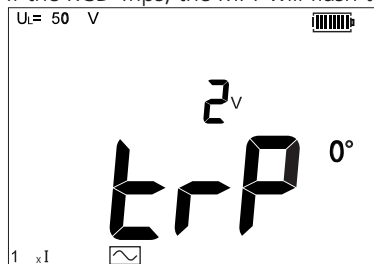

NOTE: For Type AC RCDs there is no need to perform a 180° test on the 1/2 I mode, as the test uses a full AC waveform.

8.4 1 x I RCD current rating (Tripping test on 30 mA RCD)

1. Set the LEFT rotary range knob to the **I** RCD test range.

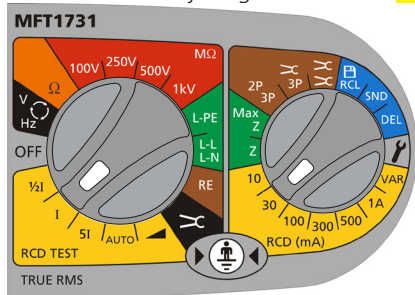

2. Connect the instrument as in 8.3.
3. Press the **↔** mode button to select 0°.
4. Press the TEST button.

The Display should show one of the following:

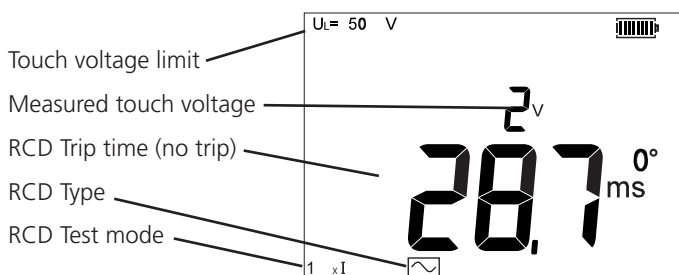

*any value below 300 ms indicates an RCD has tripped in an adequate time.

5. Press the **↔** mode button to select 180°
6. Repeat the above test.

Record the higher of the two values.

8.5 5 x I RCD current rating (Tripping test on 30 mA RCD)

Repeat the test sequence in 8.4 but with the LEFT rotary range knob to the **5I** RCD test range.

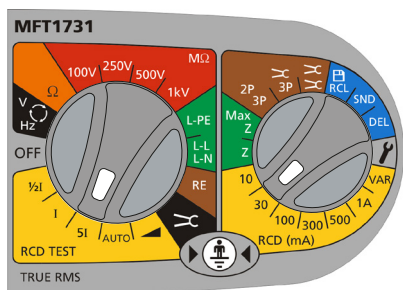

1. Press the **↔** mode button to select 0°.
2. Press the TEST button.

The display should show one of the following:

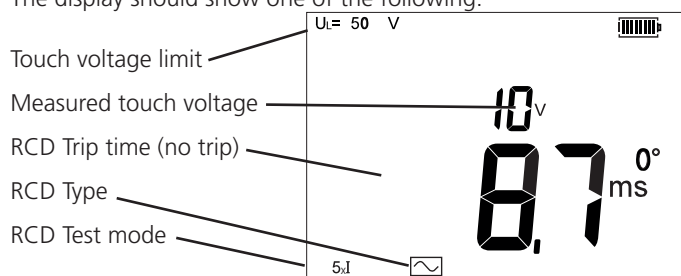

*any value below 40 ms indicates an RCD has tripped in an adequate time.

3. Press the  mode button to select 180°.
4. Repeat the above test.

Record the higher of the two values

8.6 Ramp test (Also available on the MFT70 as a GFCI test)

The RCD trip current is measured by applying a test current of half the rated trip current and increasing this every 300 ms (or 500 ms for type S RCDs) from 30% to 110% of the RCD current rating. When the RCD trips, the current flowing is recorded and displayed in mA.

Making a measurement

1. Select the appropriate RCD rated current on the right hand rotary switch **30** = 30 mA etc.
2. Select the RAMP test on the left hand range knob.

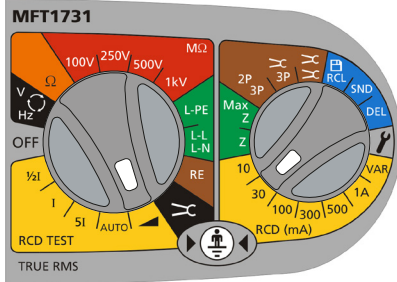

3. Press the TEST button
The RCD should trip and the display show the trip current in mA.

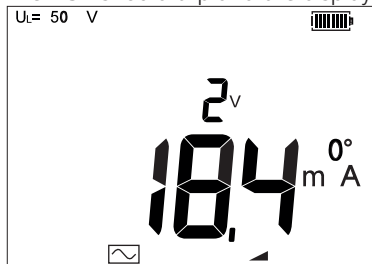

If the RCD fails to trip, >***mA is displayed, where *** = 110% of the nominal RCD trip current.

NOTE: The MFT70 will test a GFCI to ensure it trips and interrupts the supply under fault conditions. On occasion, where the GFCI is particularly sensitive. It may trip too fast for the instrument to provide a value of trip current and 'trp' will be shown in the display. A fail is where the GFCI fails to trip and does not interrupt the supply.

8.7 Type A (DC Sensitive) RCD test

'Type A' RCDs are sensitive to pulsed DC as well as AC fault currents, and are tested with a pulsed waveform. The RMS current is $\sqrt{2}$ x the rated operating current of the RCD. As with the normal RCDs, these should be tested with 0° and 180° polarity.

1. To select a Type A RCD see section 8.2



These are tested in exactly the same manner as those tested in section 8.3 to 8.6.

Note: Type A RCDs should be tested at 0° and 180° on 1/2xl, 1xl and 5xl

8.8 Type B (Pure DC) RCD test (not MFT1711)

'Type B' RCDs are sensitive to pure DC fault currents, as well as pulsed AC and ordinary AC fault currents. First they are tested as Type A then Type B, using a pure DC test current.

Type 'B' RCD's are only tested on the 1xl range.

1. Test the RCD in 'Type A' mode for 1/2xl, 1xl and 5xl if it is a 30 mA RCD. Test it in 1xl only if it is > 30 mA.
2. To select a Type B RCD press and hold the mode button  repeatedly until the  symbol is displayed.
3. Connect the Red (L1), Green (L2) and Blue (L3) terminals of the MFT to the RCD Live, Neutral and Earth as below ('Type AC' and 'Type A' RCD's only need Phase and Earth connections).

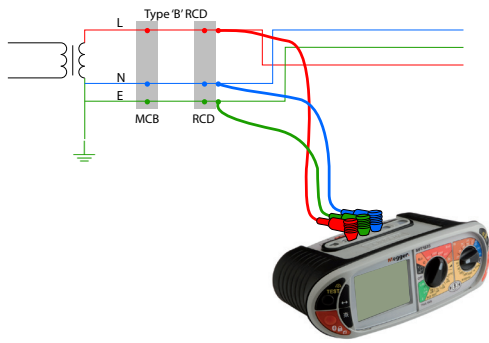

4. Select the 1xl range on the left range knob, and the current rating of the RCD on the right range knob.
5. Press the TEST button.
6. The RCD should trip and display the trip time in ms. The “Touch Voltage” is displayed on the small digital readout. The trip current in mA can be measured for Type B RCD’s using the ramp test.

Notes: Only 1xl is available. Selecting other test currents will reset the test type to AC.
Only 10 mA, 30 mA, 100 mA and 300 mA test options are available on DC testing.

8.9 Variable RCDs

1. To test an RCD with a variable trip current, select the **VAR** option on the secondary (right) range knob.
2. Press the MODE button to select the symbol.

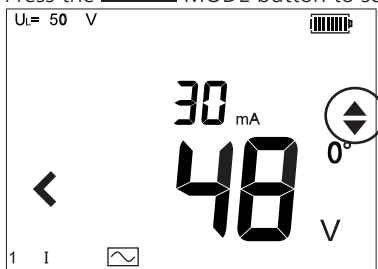

3. Use the UP and DOWN arrows on the right hand TEST and LOCK buttons to set the tripping current to match that on the variable RCD.

The tripping current can be selected as below;

10 mA to 50 mA	– 1 mA steps
50 mA to 500 mA	– 5 mA steps
500 mA to 1000 mA	– 10 mA steps

4. Save this current using the left hand Red LOCK button.
5. Test using the previous test options above.

8.10 AUTO RCD testing

The AUTO function of the RCD test options automatically performs the 1/2xl, 1xl and 5xl in both 0° and 180°, without touching the MFT. The operator can stand by the RCD and reset the device each time it trips.

Test sequence in AUTO mode:

RCD Type	AC	AC - S	A	A - S	B
1/2x I at 0°	Y	Not available	Y	Not available	Not available
1/2 x I at 180°	Y		Y		
1 x I at 0°	Y		Y		
1 x I at 180°	Y		Y		
5 x I at 0°	Y		Y		
5 x I at 180°	Y		Y		

To test the RCD in AUTO mode

1. Select the AUTO range on the left range knob
2. Select the RCD Type as in section 8.2 above.

3. Connect the Red (L1) and Green (L2) terminals of the MFT to the RCD as in section 8.3.
4. Press the TEST button on the MFT. The test sequence as in the table above will be performed.

Each time the RCD trips, it should be reset. The MFT automatically detects the reset and continues testing until the RCD stops tripping. The MFT will display "END"

5. Return to the MFT and press the mode  button to scroll through the test results in sequence.

8.11 3 Phase RCD testing (not MFT1711)

The MFT1700 series is designed to test RCDs on 3 phase installations.

To test RCDs in a 3 phase system each RCD is tested as a single RCD, from Phase to earth. As described in section 8.1 to 8.5.

Where no earth is available, the upstream/downstream method can be used. This requires testing across two phases, as below.

1. To test Phase 1 RCD, connect the MFT Red (L1) terminal to the downstream (o/p) of the RCD to be tested.
2. Connect the Green (L2) terminal of the MFT to the upstream phase of an RCD on a separate phase.

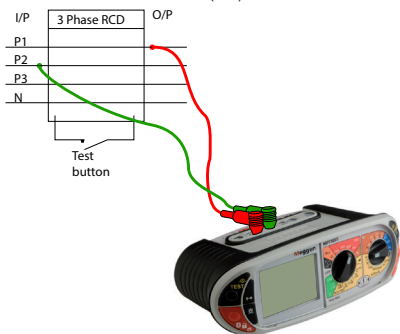

3. Press the TEST button.
4. The MFT will display the trip time of the RCD.

8.12 Touch voltage display

The voltage to which an earth conductor may rise during an RCD test. The limit for touch voltage is 50 Vac or 25 Vac, depending on the environment.

Touch voltage is caused by excessive resistance in the earth circuit when a load is placed between the live and earth conductors.

Touch voltage is displayed:

- at the end of an RCD test if the voltage is below the safe limit
- before an RCD test is started if it would exceed the safe limit.

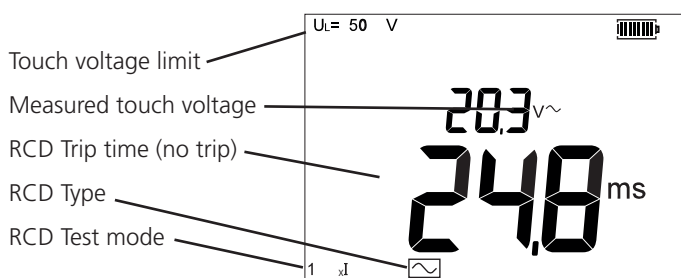

Touch voltage is calculated using the nominal trip current of the RCD x Earth resistance. For example:

$$\text{RCD trip current} = 30 \text{ mA}$$

$$\text{Earth resistance} = 1000 \Omega$$

$$0.03 \text{ A} \times 1000 \Omega = 30 \text{ V}$$

If the calculated touch voltage is less than the Touch voltage limit, the RCD test will proceed. If it is greater than the limit set, the test is halted.

The Touch Voltage limit is set in section - UL 25 V, 50 V, 60 V

Notes: The touch voltage is always displayed using the nominal trip current of the RCD (ie 1xI).

If using the 1/2xI or 5xI test ranges, the touch voltage will still be displayed for 1xI test current, as per IEC 61557-6.

5xI can create real touch voltages during the tests that are higher than the displayed value. If this voltage exceeds the touch voltage limit (UL) the test will be stopped.

Under these conditions the display will show the calculated touch voltage on the small digital segments and >50 V on the larger digital segments, as below:

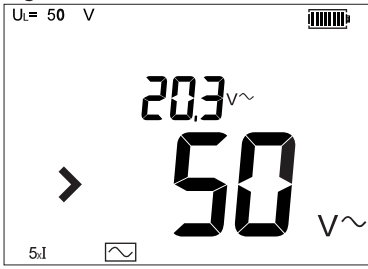

8.13 Measurement methods and sources of error

RCD Testing - Method of measurement

A two wire lead, or mains plug lead should be used for this measurement. A constant current source is connected across the supply and the time taken for the supply to trip is measured by the instrument in ms.

RCD Testing - Possible sources of error

Measurement results can be affected by the following:

- Significant operating errors can occur if loads, particularly rotating machinery and capacitive loads, are left connected during tests.
- A poor connection to the circuit under test.

8.14 Useful information

It is only necessary to test the 10 mA and 30 mA at 1/2xl, 1xl and 5xl. All other RCDs only need to be tested at 1/2xl and 1xl.

Always press the RCD TEST button on the RCD to ensure the function works.

It is recommended the RCD test button is tested AFTER the timing tests above are complete. This can identify RCDs that may stick or fail if not checked periodically.

9. Earth resistance measurement

The Megger MFT1731 and MFT70 offer a unique solution to the measurement of earth or ground electrode (rod) supporting 2 and 3 wire measurements:

These models can use an optional current clamp (ICLAMP) to measure electrode (rod) resistance without disconnection, leaving the installation earthing system intact (Attached Rod Technique, ART). Additionally, they can drive an optional voltage-inducing clamp (VCLAMP) which, in conjunction with the ICLAMP, can be used to make stake-less measurements of the earthing system.

For the principles of Earth resistance testing go to Appendix F

9.1 Connection terminals

The terminal references used on the MFT are:



The terminal colours correspond to the Earth test lead set, **not the standard test leads shipped with the MFT1700.**

MFT1731 and MFT70 Connection panel

9.2 Touch voltage limit

Adjust the touch voltage limit to 25 V or 50 V depending on location. Refer to section 10.

9.3 Making a measurement - Two pole resistance measurement

1. Connect the instrument as shown below.

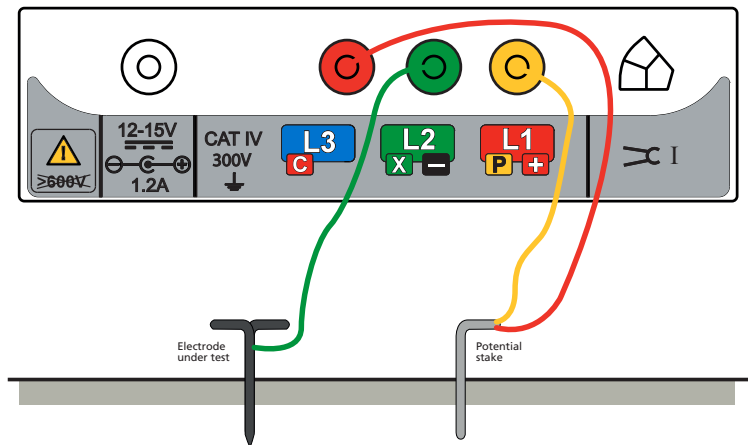

NOTE: on the MFT70, the red wire can be omitted.

2. Set the rotary selector switch to the **2P** position.

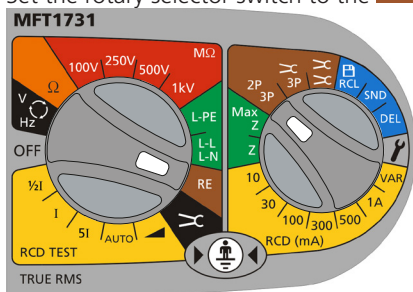

3. Press and release the **TEST** button.

The instrument will perform pre-measurement check, the status of which will be indicated on the display.

The two-terminal resistance reading will be displayed

Note: The test voltage used to make the two-terminal resistance reading is AC and may not be suitable for continuity testing according to some local regulations.

9.4 Making a measurement – Three terminal resistance measurement

1. Connect the instrument as below.

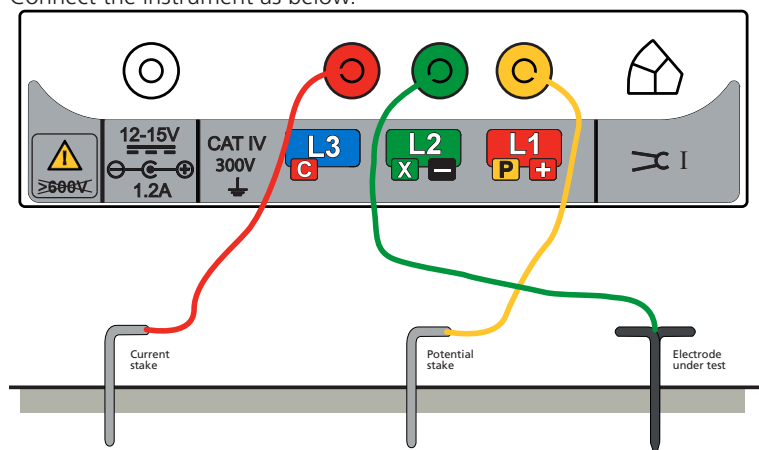

2. Set the rotary selector switch to the **2P** / **3P** position.

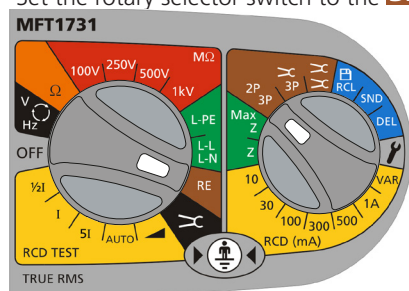

3. Press and release the **TEST** button.

The instrument will perform pre-measurement check, the status of which will be indicated on the display. The three-terminal resistance reading will be displayed.

9.5 Making a measurement – Three terminal resistance measurement using ART

1. Connect the instrument as BELOW. Close the \approx ICLAMP around the conductor under test.

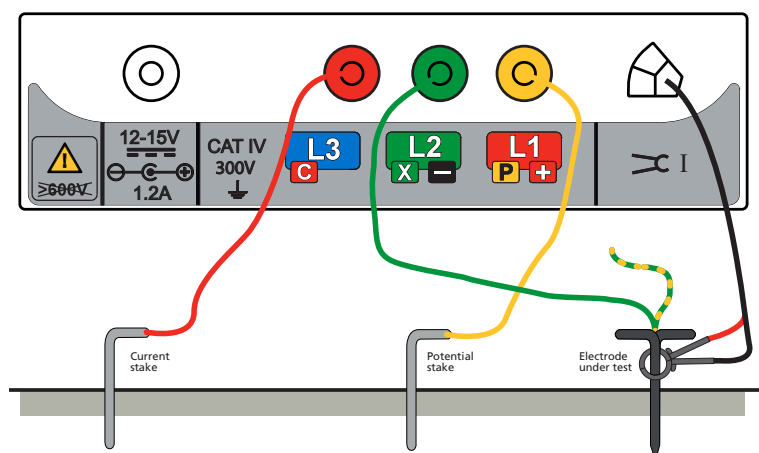

2. Set the rotary selector switch to the **3P** position.

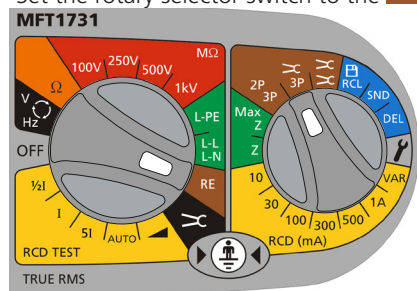

- Press and release the **TEST** button [by holding the **TEST** button, the resistance measurement will be continually updated].

The instrument will perform pre-measurement checks, the status of which will be indicated on the display. The three-terminal resistance reading using ART will be displayed

Note:

- Ensure that the ICLAMP jaw mating surfaces are free of dust and contamination and that they contact completely when the ICLAMP is closed.
- Currents carried by conductors in close proximity to the ICLAMP may affect calibration and reduce the accuracy of measurements made.
- Re/Rs ratio must be less than 100, where Re = Earth resistance, Rs = Shunt resistance

9.6 Two-clamp stake-less measurement

Before making a stake-less measurement, please follow the procedures contained in the sections on ICLAMP calibration.

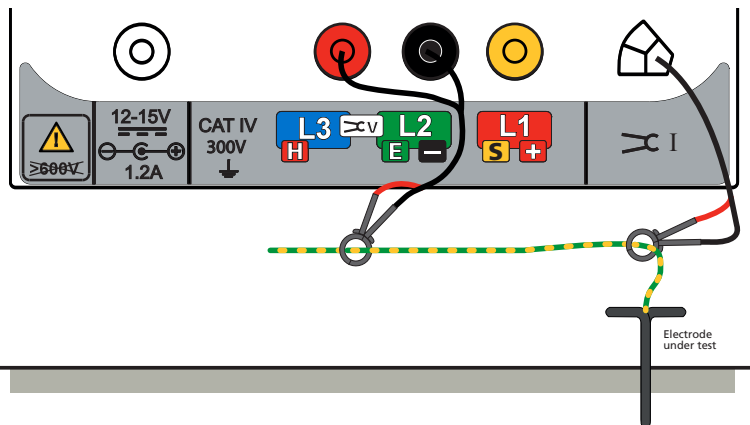

- Ensure the rotary selector switch is in the **OFF** position.
- Connect the instrument as shown above.
- Close the ICLAMP around the conductor under test. Ensure the arrow on the side of the jaw is pointing in the same direction as the arrow on the VCLAMP.
- Close the VCLAMP around the conductor under test. Ensure the arrow on the side of the jaw is pointing in the same direction as the arrow on the ICLAMP.

(If one of the clamps is reversed, the main display shows 'Err' momentarily with 'REV' on the auxiliary display together with the V clamp symbols).

- Ensure a minimum separation of 100 mm between the ICLAMP and VCLAMP.
- Set the rotary selector switch to the Ω position.

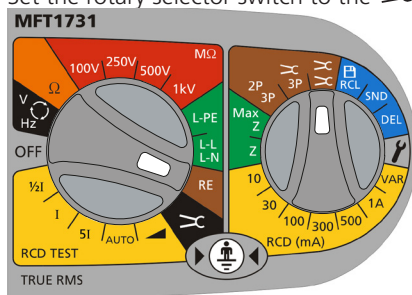

- Press and release the **TEST** button. The instrument will perform pre-measurement checks, the status of which will be indicated on the display.
- The stake-less resistance reading will be displayed.

Note:

- Ensure that the VCLAMP and ICLAMP jaw mating surfaces are free of dust and contamination and that they contact completely when the VCLAMP and ICLAMP are closed.
- Currents carried by conductors in close proximity to the VCLAMP and ICLAMP may affect calibration and reduce the accuracy of measurements made.
- If the VCLAMP opens at any time after the **TEST** button is pressed, the test will be aborted.

10. Setup options

The Setup options allow the MFT to be configured to best suit the type of testing to which it will be used.

To enter Setup, right (secondary) range knob to  Setup. Set the left (primary) range knob to any function other than OFF.

The display will show **VER** and the software version number. It will then change to the first message in the list below:

Message	Function	Options	Factory setting
RST	Restore factory settings	NO / YES	NO
INS*1	Insulation limit alarm – Buzzer sounds if result is higher than limit set	0.5, 1, 2, 3, 4, 5,7, 10, 50, 100, 500 MΩ	1 MΩ
LOC	Insulation test lock.	ON / OFF	ON
bUZ	Continuity limit alarm – Buzzer sounds if result is below than limit set	0.5, 1, 2, 5, 10, 50, 100 Ω	2 Ω
ISC*2	Continuity test current	15 mA / 200 mA	200 mA
REV	Auto reverse continuity test	ON / OFF	OFF
looP	Loop test lead compensation	0 – 0.3 ohms	0.07 Ω
LAS	Loop test AUTO start	ON/OFF	OFF
L-PE 2Hi	Enable/Disable high current loop test	ON/OFF	ON
L-PE 2Lo		ON/OFF	ON
RAS	RCD AUTO start	ON/OFF	OFF
UL	Touch voltage limit	25 V / 50 V / 60 V	50 V
OFF	Auto switch OFF in minutes	2 m / 20 m	20 minutes
bAC	Backlight AUTO mode/manual mode In Auto mode, backlight comes on when at start of test, end of test, range change etc.	Auto / nor	Auto
bAt	Alkaline or NiMH selection	1.5 V or 1.2 V	Depending on instrument
StR	Store mode IN = Internal Bt = Bluetooth® only	IN / bt	IN
bt	Bluetooth® pairing	bt1, bt2, bt3, bt4, bt5	bt1
< >	Searching for pair		

INS*1 is not available on MFT1711

ISC*2 is not available on MFT1711

To scroll down the options, press the  button. Each option will be is played in sequence.

To change the setting of each function, for example, INS limit alarm from 1 MΩ to 2 MΩ, use the right hand TEST and LOCK keys (also marked with UP/DOWN arrows).

Changing an option will set the LOCK symbol and warning triangle flashing.

To save the change press the left LOCK button

To exit SETUP, turn the right range knob away from 

All settings can be restored to the factory defaults by setting RST to YES. Saving this setting will reset all options to default. The RST will then set back to NO.

11. Warning messages

The following warning messages may be displayed during the testing process.

Characters which appear in the aux (small) digit field on the display are shown here in a slightly smaller font size.

11.1 Startup warnings

"UNC" -Instrument is un-calibrated

11.2 Battery

"bAt" -Low battery

11.3 Battery charger

"bAt CHA" -Battery charging

"bAt FUL" -Battery fully charged

11.4 Fuse warning

"FUS" -Fuse blown.

11.5 Invalid rotary switch setting

"ERR - - -" -General error – invalid combination of rotary switches.

11.6 Continuity test

"VOL 0-L" -Voltage overload during test

11.7 Insulation test

"1000 V 1000 V" -Flashing warning before 1 kV test.

"VOL 0-L" -Voltage overload during test

11.8 RCD Test (or GFCI)

"trp" -Supply tripped unexpectedly.

">50V" -Test aborted due to danger of exceeding touch-voltage limit.

"Err con" -Hardware problem detected during High Current Loop test or RCD test.

11.9 RCD range selection errors

"ERR >1000 mA" -Requested current is >1000 mA.

"ERR - - -" + Type A -In Type A mode -Instrument has been set for Type A test, but Type A test is not valid with this setting.

"ERR - - -" + Type B -In type B mode - Instrument has been set for Type B test, but Type B test is not valid with this setting.

"ERR - - -" + Type S breaker symbol
-Instrument has been set for Type S test, but Type S test is not valid with this setting.

"ERR HI mA" -On VAR range, current is set too high for the selected test.

11.10 Loop Test

"trp" -Supply tripped unexpectedly.

">50V" -Test aborted due to danger of exceeding touch-voltage limit.

"Err con" -Hardware problem detected during High Current Loop test or RCD test.

"Hot" -Internal resistors are too hot. Also shows thermometer.

"Hot" -Internal heat sink is too hot. Also shows thermometer.



-Supply noise detected. Loop test time will be extended.

11.11 Test will not start

- "CON" -Wrong connection to instrument.
- "hot" -Internal resistors are too hot. Also shows thermometer.
- "Hot" -Internal heat sink is too hot. Also shows thermometer.
- "VOL >280V" (for example)-Supply voltage is too high.
- "L-N <48V" (for example) -Voltage on terminals is too low for L-N loop test
- "L-E <48V" (for example) -Voltage on terminals is too low for L-E loop test or RCD test
- "FRE <45" -Supply frequency is too low for loop test or RCD test
- "FRE >65" -Supply frequency is too high for loop test or RCD test
- "NO REF" -Loop R1+R2 test attempted without having previously done a Zref test.

Appendix A – Sending, Storing, Deleting and Recalling Test Results (Not MFT1711 or MFT1721)

Test results can be stored in the MFT, or downloaded immediately to a Bluetooth® compatible device running PowerSuite Mobile, or both. See section 10 Setup,

Test results are stored in “Folders” against a set of circuit references as below:

Folders:

Jb	000 to 255	Job number – Allows results from different locations to be saved in one instrument
Db	001 to 255	Distribution board number
CIR	000 to 255	Circuit reference number
PHA	001 to 003	Phase number

Circuit type:

In addition, the following circuit descriptors are used to identify on which part of the circuit the measurement was made:

Insulation:

Symbol	Definition
L – E	Live to Earth Test
L – n	Live to Neutral Test
n – E	Neutral to Earth Test
L - L	Live to Live Test
- - -	No connection selected

Continuity:

Symbol	Definition
R1	Live
R2	Circuit Protective Conductor
R12	R1 + R2
RR1	Ring Circuit Phase-Phase
RR2	Ring Circuit CPC-CPC
RRN	Ring Circuit Neutral-Neutral
- - -	No connection selected

Loop Testing:

L-E range measurements are automatically saved as L-E connections
L-N range

Symbol	Definition
L – E	Live to Earth Test
L – n	Live to Neutral Test
L - L	Live to Live Test

RCD/GFCI:

Not relevant

Earth testing:

Earth measurements are saved under a job number only

Storing Test Results in the internal memory

Note that in order to store test data, the Store Mode needs to be set to internal or internal and Bluetooth®. See section 10 Setup options for further details.

1. Perform the desired test as described previously.
2. Press and release the Bluetooth® (Lock) button to display the first option. This will be the connection for some tests (Insulation, Continuity, Loop L-L/L-N) or Job number for other tests.
3. Use the Right Lock / RIGHT TEST buttons to scroll through the values until the one you need is reached.
4. Press and release the Bluetooth® (Lock) button again to display each of the remaining options (Job, Distribution Board, Circuit, Phase) and use the Right Lock / RIGHT TEST buttons to change these values as required.
5. To complete the store, press and hold the Bluetooth® (Lock) button until ‘Str Ok’ is displayed.

Notes

1. If a particular option does not need to be changed from the value set during the previous stored result, it does not need to be displayed prior to storage.
2. The only available option for stored Earth test results is the Job number.

Deleting Test Results from the internal memory

1. Turn the RIGHT rotary range knob to the DEL range.
2. Use the Bluetooth® (Lock) button to select either LSt (last stored result) or ALL (all stored results).
3. Press and hold the Bluetooth® (Lock) button until 'NO' is displayed.
4. Use the Right Lock / RIGHT TEST buttons to display 'YES'.
5. Press and hold the Bluetooth® (Lock) button until 'dEL Ok' is displayed.

Recalling Test Results to the display

1. Turn the RIGHT rotary range knob to the RCL range.
2. Use the Bluetooth® (Lock) button to select either LSt (last stored result) or ALL (all stored results).
3. Press and hold the Bluetooth® (Lock) button until the result is displayed on the screen.
4. If ALL has been selected, use the Right Lock / RIGHT TEST buttons to scroll through the stored results.
5. If TEST is displayed, this indicates further data is available for the displayed result. Use the LEFT TEST button to display this as required. E.g. for Insulation, the test voltage is available for viewing.

Sending stored test results via Bluetooth®

1. Run Megger Download Manager
2. Using the appropriate driver, follow the on-screen instructions.

Sending individual (Blobbing) test results

Note that in order to Blob test data, the Store Mode needs to be set to Bluetooth® or internal and Bluetooth®. See section 10 Setup options for further details.

To force a particular test result into a specific certificate box double click the box within the certificate prior to Blobbing the result.

Insulation testing

1. Perform an Insulation test as described previously.
2. Press and hold the Bluetooth® (Lock) button to display the first option. Release button when L-E displayed.
3. Use the Right Lock / RIGHT TEST buttons to scroll through the options until the one you need is reached (L-E, L-n, n-E, L-L or ---).
4. Press the Bluetooth® (Lock) button to send the test result to your PC or mobile device. The display chevrons will alternate whilst the connection is being established. When connected, the Bluetooth® symbol will flash whilst the result is transmitted.
5. The test results will now appear in the correct box in the certificate open on your PC or mobile device.

Continuity testing

1. Perform a Continuity test as described previously.
2. Press and hold the Bluetooth® (Lock) button to display the first option. Release button when R12 is displayed.
3. Use the Right Lock / RIGHT TEST buttons to scroll through the options until the one you need is reached (R2, R12, R1, RR1, RR2 or ---).
4. Press the Bluetooth® (Lock) button to send the test result to your PC or mobile device. The display chevrons will alternate whilst the connection is being established. When connected, the Bluetooth® symbol will flash whilst the result is transmitted.
5. The test results will now appear in the correct box in the certificate open on your PC or mobile device.

Loop testing (L-PE)

1. Perform a Loop test as described previously.
2. Press and hold the Bluetooth® (Lock) button to send the test result to your PC or mobile device. Release the button when the display chevrons start to alternate. This indicates the connection is being established. When connected, the Bluetooth® symbol will flash whilst the result is transmitted.

3. The test results will now appear in the correct box in the certificate open on your PC or mobile device.

Loop testing (L-L/L-N)

1. Perform a Loop L-L/L-N test as described previously.
2. Press and hold the Bluetooth® (Lock) button to display the first option. Release button when L-N displayed.
3. Use the Right Lock / RIGHT TEST buttons to scroll through the options until the one you need is reached (L-N or L-L).
4. Press the Bluetooth® (Lock) button to send the test result to your PC or mobile device. The display chevrons will alternate whilst the connection is being established. When connected, the Bluetooth® symbol will flash whilst the result is transmitted.
5. The test results will now appear in the correct box in the certificate open on your PC or mobile device.

RCD testing

1. Perform a RCD test as described previously.
2. Press and hold the Bluetooth® (Lock) button again to send the test result to your PC or mobile device. The MFT test result will flash whilst the result is transmitted.
3. The test results will now appear in the correct box in the certificate open on your PC or mobile device.

For Auto RCD tests all results are automatically transmitted to the correct boxes on the certificate (the appropriate value must be selected on the PC or mobile device for each box when prompted).

Earth testing

1. Perform an earth test as described previously
2. Press and hold the Bluetooth® (Lock) button again to send the test result to your PC or mobile device. The MFT test result will flash whilst the result is transmitted.
3. The test results will now appear in the correct box in the certificate open on your PC or mobile device.

Appedix B- Downloading data via Bluetooth® (Not MFT1711 or MFT1721)

Bluetooth® Pairing (PC or Laptop)

1. Turn your MFT 'on' to any setting, and turn the smaller dial to the settings ('spanner') position to enter the setup mode.
2. Press the  button on the MFT until you see 'StR' appear on the display. At this point you should ensure that 'bt' is displayed in larger letters on the main part of the MFT's display.

If this is not the case use the right-hand TEST & Lock buttons as UP/DOWN arrows to scroll through the options to select your chosen communication method.

- IN = Internal Only
bt = Bluetooth® Only
3. Once you have selected your chosen storage/communication location, press the left hand Bluetooth®/Lock button once to save this as your preference. The Lock icon will now stop flashing in the upper left hand corner of the MFT's display and disappear to indicate your preference has been saved.
 4. You will now need to press the  arrow once to display the 'bt' setup option.
 5. To enter the Bluetooth® pairing mode you will now need to push and hold down the left hand Bluetooth®/Lock button until you see two oscillating chevrons (<>) appear on the display and then release. The Bluetooth® pairing will fill the first empty slot available, if there are no empty slots left, it will overwrite the currently shown slot on the MFT's display. If all slots are currently in use and you wish to add another, display on the screen the slot that you want to overwrite. To do this use the right-hand TEST & Lock buttons as UP/DOWN arrows to scroll through all 5 slots.

From your PC/Laptop run the 'Add Bluetooth® Device' wizard.

- You will be prompted during the pairing process to enter your passkey, enter '1234'
 - During the pairing process you may also be prompted to enable the 'Bluetooth® Serial Port'. Ensure this option is chosen if you are given this option.
6. Once you have clicked 'Finish' on the wizard on the PC/Laptop the pairing process will now be complete and your PC/Lap-top pairing code will be displayed on the MFT. You can now turn the dial and leave the settings ('Spanner') position on the MFT.

Bluetooth® Pairing (Windows CE)

1. Set the MFT Range knob to the Bluetooth® SET UP position.
2. Press the Bluetooth® (Lock) button on the MFT, the MFT will show '- - -' if no pairing exists or the last three digits of a paired identity if already paired. If these three digits are the last three digits of your Bluetooth® identity code (e.g. 963) then you are already paired with it. If you don't recognise them or are unsure then continue with the pairing process.
 - (i) Turn on your PDA and select 'Start' then 'Settings'.
 - (ii) Select the 'Connections' Tab.
 - (iii) Select the 'Bluetooth®' symbol and select 'Turn on'.
 - (iv) Select 'Use Bluetooth® Manager' option.
 - (v) Select 'Menu' and 'Paired Devices'
 - (vi) If there are no paired MFTs shown then select 'Add'.

Note: If there is a MFT symbol present check that it has the serial number displayed as your MFT. If this isn't the case then delete the MFT from the PDA and continue with the pairing procedure.

(vii) Select the Magnifying Glass symbol to start the pairing process.

3. Push the Bluetooth® (Lock) button again to start the pairing process, the MFT will display '<> - - -'
4. Once paired double click the MFT symbol on the PDA and enter the access key code 1234.
5. The MFT will display the last three digits of your Bluetooth® identity code when a successful pairing has been achieved (e.g. <>963).

Bluetooth® Pairing (Windows Mobile 5 Smartphone)

1. Set the MFT Range knob to the Bluetooth® SET UP position.
2. Press the Bluetooth® (Lock) button on the MFT, the MFT will show '- - -' if no pairing exists or the last three digits of a paired identity if already paired. If these three digits are the last three digits of your Bluetooth® identity code (e.g. 963) then you are paired with it.
If you don't recognise them or are unsure then continue with the pairing process.
 - (i) Turn on your mobile and press the left hand button to select 'Start' menu.
 - (ii) Select the 'Connections' symbol.
 - (iii) Select the 'Bluetooth®' symbol.
 - (iv) Press the right hand Menu button.
 - (v) Select the Devices symbol.
 - (vi) Select the 'Menu' symbol and the select the 'New' symbol.
 - (vii) If there are no paired MFTs shown then select 'Add'.

Note: If there is a MFT symbol present check that it has the serial number displayed as your MFT. If this isn't the case then delete the MFT from the PDA and continue with the pairing procedure.

3. Push the Bluetooth® (Lock) button again to start the pairing process, the MFT will display '<> - - - -'
4. On the Windows Mobile 5 once paired select the MFT symbol on the mobile and enter the access key code 1234.
5. The MFT will display the last three digits of your Bluetooth® identity code when a successful pairing has been achieved (e.g. <>963).
6. On the Windows Mobile 5 press the left hand menu button four times to select the following in sequence; 'Next', 'OK', 'Next' and 'Done'.
7. Continue to press the left hand button until you return to the windows desktop display.

Bluetooth® Pairing (Palm v5)

1. Set the MFT range knob to the Bluetooth® SET UP position.
2. Press the Bluetooth® (Lock) button on the MFT, the MFT will show '- - -' if no pairing exists or the last three digits of a paired identity if already paired. If these three digits are the last three digits of your Bluetooth® identity code (e.g. 963) then you are already paired with it.
If you don't recognise them or are unsure then continue with the pairing process.
3. (i) Select 'Bluetooth®' from the main Palm desktop and ensure is turned on.
(ii) Select the 'Setup Devices' symbol.
(iii) Select the 'Trusted Devices' symbol.
(iv) Select the 'Add Devices' symbol.

Note: If there is a MFT symbol present, check that it has the serial number displayed as your MFT. If this isn't the case then delete the MFT from the Palm and continue with the pairing procedure.

4. Push the Bluetooth® (Lock) button again to start the pairing process, the MFT will display '<> - - - -'
5. On the Palm device once paired select the MFT symbol on the display and select 'OK'.
6. Enter the access and select key code '1234' and select the top left hand menu button 'OK'.
7. The MFT will display the last three digits of your Bluetooth® identity code when a successful pairing has been achieved (e.g. <>963).
8. On the Palm device select the 'Done' twice to get back to the Bluetooth® screen.
9. Select the 'Home' button to return to the main Palm desktop.

Bluetooth® Pairing (Symbian S60 Version 3)

1. Set the MFT Range knob to the Bluetooth® SET UP position.
2. Press the Bluetooth® (Lock) button on the MFT, the MFT will show '- - -' if no pairing exists or the last three digits of a paired identity if already paired.
If these three digits are the last three digits of your Bluetooth® identity code (e.g. 963) then you are already paired with it.
If you don't recognise them or are unsure then continue with the pairing process.
3. (i) Select 'Bluetooth®' from the main Symbian desktop and ensure it is turned on.
(ii) Select the right hand Tab to show paired devices.
(iii) Select the top left hand menu button then the 'New Paired devices' symbol.

Note: If there is a MFT symbol present check that it has the serial number displayed as your MFT. If this isn't the case then delete the MFT from the Symbian and continue with the pairing procedure.

4. Push the Bluetooth® (Lock) button again to start the pairing process, the MFT will display '<> - - - -'
5. Once paired select the MFT symbol on the display and select 'OK'.
6. Enter the access and select key code '1234' and select 'OK'.
7. The MFT will display the last three digits of your Bluetooth® identity code when a successful pairing has been achieved (e.g. <>963).
8. On the Symbian device select the top left hand menu button 'Yes' to authorise the Symbian device to make the connection automatically.
9. Select 'Exit' to return to the main Symbian desktop.

Appendix C - Installation category definitions

IEC 61010-2-030 defines measurement categories II to IV relating to transient over-voltages and locations within electrical installations.

Examples of electrical installation category rating are:

Category II - a mains socket outlet,

Category III - the wiring between the socket outlets and the consumer unit,

Category IV - the supply to the consumer cut-out from the distribution network transformer.

For further information on category ratings visit the relevant product page on www.megger.com.

Appendix D - Safe working practice

It is important that before the instrument is used, and when testing is completed, the functions of the instrument are proven to be working. This is to ensure that a hazardous condition is not mis-reported by the instrument as being safe. For example:

By checking the voltage range correctly measures 230 Vac on a separate electrical source, prior to measuring the circuit to be tested, and then checking it at the end of testing, a live circuit is less likely to be mis-reported as dead.

The Megger MTB7671 test box is available for checking all electrical functions of the multi-function tester (excluding earth tests) between calibration dates.

Appendix E - Cleaning and maintenance

The MFT1700 should only be opened or repaired by an approved Megger service or by Megger Instruments Limited.

To clean the instrument, use a damp cloth or isopropyl alcohol if available. To clean the display window only use a lint free cloth.

For repairs and warranty, see page 40.

Appendix F - Earth resistance testing – Basic principles

F.1 Principle of operation (three-terminal resistance measurement)

The classic “fall of potential” test is used to accurately measure the resistance of an earth electrode using auxiliary stakes driven into the soil, which form a circuit for the test current injection and voltage measurement as used for the two-terminal method.

The MFT injects an AC current of known magnitude into the system under test and measures the voltage developed across it as shown in Figure 4. The system resistance is a simple ratio as per ohm's Law. In this case, the potential stake is moved by fixed increments in a straight line between the electrode under test and the current stake. At each location, the resistance is calculated as $R=V/I$. A graph of resistance versus potential stake position is plotted and the resistance of the electrode under test is taken to be the point at which the curve is flattest.

Empirical testing has shown that with suitably positioned stakes, this method can be shortened by placing the potential stake at a distance of approximately 62% between the electrode under test and the current stake, i.e. at $A = 0.62 \times B$.

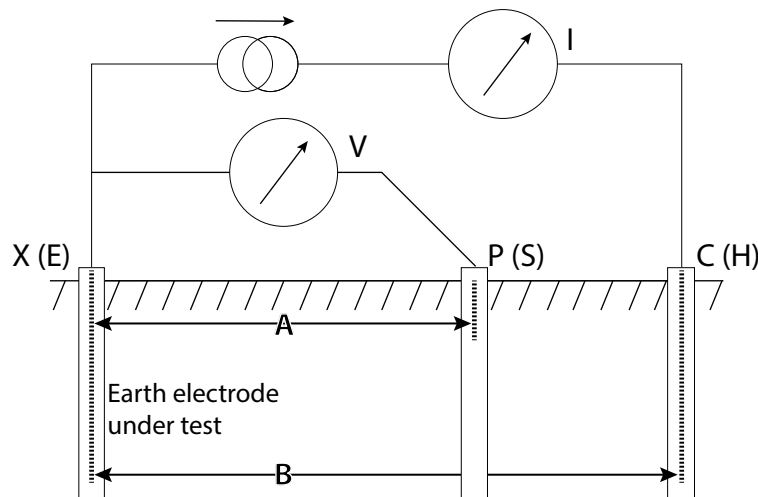

Schematic for three-terminal resistance measurement

F.2 Principle of operation (three-terminal resistance measurement using ART)

The classic three-terminal test method has a disadvantage, namely that the electrode under test must be disconnected from the system it is supposed to protect in the event of a power system fault. The reason for this is that the injected test current will take all possible routes to ground and not all of it will necessarily flow through the electrode under test. In this case, the instrument will make a reading of the entire earthing network, not just the individual electrode.

By using a current transducer (the Megger ICLAMP) to measure the current flowing through the electrode under test as a fraction of the total test current injected, the instrument can determine the individual resistance. This arrangement is shown below:

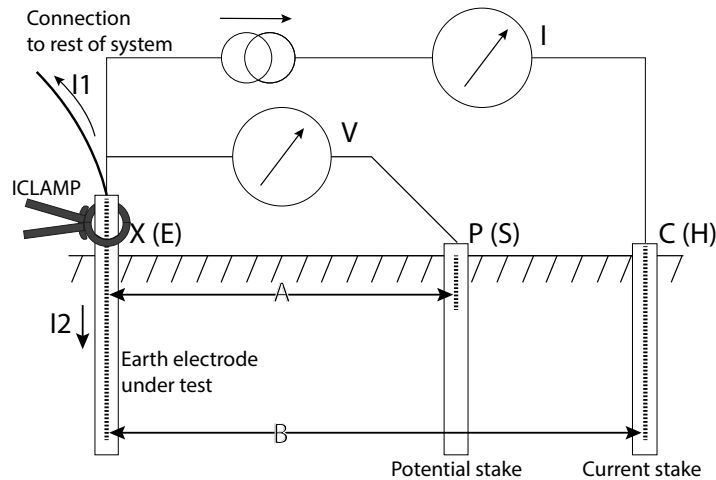

Schematic for three-terminal resistance measurement using

In this configuration, the injected test current I splits along two paths into I_1 (flowing into the connected earthing system) and I_2 (flowing into the electrode under test, i.e. $I=I_1+I_2$). The resistance of the electrode under test is calculated as $R=V/I_2$ or $R=V/(I-I_1)$. The current transducer (ICLAMP) measures I_2 and feeds this value back to the instrument.

F.3 Principle of operation (two-clamp stake-less resistance measurement)

In this example, the electrode under test is connected to a network of other electrodes. It is either impractical or unsafe to disconnect an individual electrode for testing. Also, there might be insufficient space to perform a classic three-terminal resistance measurement. The stake-less test method using both VCLAMP and ICLAMP can be used to obtain a measurement for the electrode under test.

A defined test voltage is injected into the system using the VCLAMP, inducing a current, I , to flow and be measured by the ICLAMP. The model shown in Figure 7 can be simplified to the resistance of the electrode under test, R_x and the resistance of the other electrodes in parallel, i.e. $R_1 \parallel R_2 \parallel \dots \parallel R_n$.

Therefore, the current induced by the test voltage is $I=V/[R_x+(R_1 \parallel R_2 \parallel \dots \parallel R_n)]$. It follows that as the resistance of the other electrodes in parallel approaches zero, then the resistance measured, approaches the value of the electrode under test.

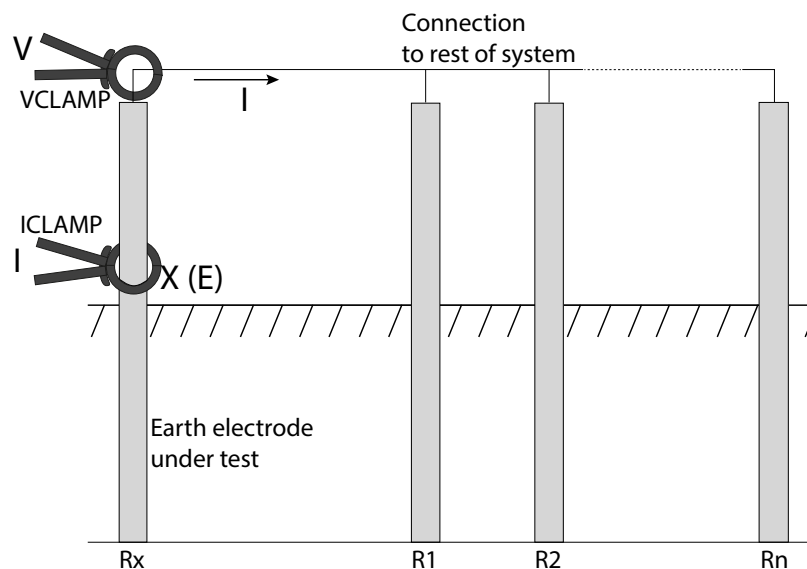

Schematic for two-clamp stake-less resistance measurement

General Specification

Accuracy

Insulation test:

1000 Volts	10 k Ω - 999 M Ω	$\pm 3\%$	± 2 digits	
500 Volts.	10 k Ω - 500 M Ω	$\pm 3\%$	± 2 digits >500 M Ω $\pm 10\%$	± 4 digits
250 Volts.	10 k Ω - 250 M Ω	$\pm 3\%$	± 2 digits >250 M Ω $\pm 10\%$	± 4 digits
100 Volts.	10 k Ω - 100 M Ω	$\pm 3\%$	± 2 digits >100 M Ω $\pm 10\%$	± 4 digits
EN61557 range:	10 k Ω - 999 M Ω (1000 V range)			
Voltage display:	$\pm 3\%$ ± 3 digits $\pm 0.5\%$ of rated voltage			
Max service error:	$\pm 15\%$ ± 2 digits.			
Short circuit current:	1.5 mA nominal test current			
Test current on load:	≥ 1 mA at min. pass values of insulation			
Output voltage tolerance:	-0% +20% at rated load or less			

Continuity / Resistance:

Intrinsic accuracy:	$\pm 2\%$ ± 2 digits	(0.01 Ω to 99.9 Ω)
	$\pm 5\%$ ± 2 digits	(100 Ω to 99.9 k Ω)
EN61557 range:	0.1 Ω to 99.9 k Ω	
Open circuit voltage	5 V ± 1 V	
Test current at 200 mA	(0 Ω to 2 Ω): >200 mA @ ≤ 2 Ω	
Test current at 15 mA	(0 Ω to 2 Ω): >15mA @ ≤ 2 Ω	
Max Service error:	$\pm 12\%$ ± 2 digits.	

Loop test 2Hi (L-PE, L-N, L-L):

Intrinsic accuracy:	$\pm 5\%$ ± 3 digits
Display range:	0.01 Ω to 1000 Ω
Supply:	48 V to 480 V* (45 Hz to 65 Hz)
Test current high:	4.0 A (at 230 V)
PSCC range:	20 kA
EN61557 range:	0.30 Ω to 1000 Ω
Max service error:	$\pm 10\%$ ± 2 digits
* MFT1711 280 V	

Loop test 3Lo, 2Lo (L-E):

Intrinsic accuracy:	0.01 Ω to 39.9 Ω $\pm 5\%$ ± 5 digits	40.0 Ω to 999 Ω $\pm 10\%$ ± 5 digits
Display range:	0.01 Ω to 1000 Ω	
Supply:	48 V to 280 V (45 Hz to 65 Hz)	
Test current:	Pulsed	
PFC range:	20 kA	
EN61557 range:	1.0 Ω to 1000 Ω	
Max service error:	$\pm 10\%$ ± 2 digits	

RCD test:

Intrinsic current accuracy:	
No trip test:	(1/2xl) -10% to 0%
Trip test:	(1xl, 2xl and 5xl) +0% to +10%.
Ramp test current:	$\pm 5\%$ ± 1 digit
Trip time:	$\pm 1\%$ ± 1 ms
Programmable step increments:	10 mA to 50 mA - 1 mA steps. 50 mA to 500 mA - 5 mA steps 500 mA to 1000 mA - 10 mA steps.
Supply:	48 V - 280 V 45 Hz to 65 Hz
Max service error:	$\pm 10\%$ ± 2 digits

Voltage:

Intrinsic accuracy:	$\pm 2\% \pm 1 \text{ V}$
EN61557-1 Range:	10 V to 600 V
Phase rotation indication.	
Max service error:	$\pm 5\% \pm 2 \text{ digits}$

Frequency:

Intrinsic accuracy:	$\pm 0.5\% \pm 2 \text{ digits}$
Resolution:	0.1 Hz
EN61557 Range:	15 Hz to 400 Hz
Max service error:	$\pm 5\% \pm 3 \text{ digits}$

Earth Test Ranges:

Intrinsic accuracy:	$\pm 2.0\% \pm 3 \text{ digits}$
ART method	$\pm 5.0\% \pm 3 \text{ digits}$
Stakeless method	$\pm 7.0\% \pm 3 \text{ digits}$
Resolution:	0.01 Ω
EN61557 range:	1.0 Ω to 1.99 k Ω
Current:	0.45 mA or 4.5 mA.
Noise rejection:	20 V pk/pk (7 V rms)
Max probe resistances:	$R_p, R_c = 100 \text{ k}\Omega @ 50 \text{ V}$
Max service error:	$\pm 20\% \pm 3 \text{ digits}$

Current (via Clamp meter):

Intrinsic accuracy:	$\pm 5.0\% \pm 3 \text{ digits}$
Resolution:	0.1 mA
EN61557 Range:	0.5 mA – 199 A
Max service error:	$\pm 10\% \pm 2 \text{ digits}$

mV Sensor input (NOT MFT1711)

Including temperature (third party module)	
	$\pm 1.0\% \pm 2 \text{ digits}$
Range	0.0 mV to $\pm 199.9 \text{ mV dc}$
Resolution	0.1 mV

Internal memory (Not MFT1711 or MFT1721)

Capacity	1000 results
Bluetooth® communication	

Power consumption:

Nominal minimum:	60 mA (Voltage range with no input voltage)
Nominal maximum:	350 mA (Active Insulation test set to 1000 V / 1 M Ω)
Range:	-20 °C to +55 °C

Temperature (via 3rd Party Module):

Intrinsic accuracy:	$\pm 1.0\% \pm 2 \text{ digits}$
Resolution:	1 °C
Range:	-20 °C to +100 °C

Environmental Specification.**Temperature**

Operational range:	-10 °C to +55 °C
Storage range:	-25 °C to +70 °C

Humidity

Operating humidity: 90% R.H. at +40 °C max.

Altitude

2000 m to full safety specification.

Weight:

1000 g \pm 10% including batteries but excluding test leads, accessories and carry case.

Dimensions:

150 mm high x 85 mm wide x 235 mm deep
(6 in. x 3.5 in. x 9.5 in.)

IP rating:

IP54

Power Supply.

Battery: Primary 6 x 1,5 V cells IEC LR6 type (AA alkaline,).

Battery: Rechargeable: 6 x 1.2 V NiMH cells EC HR6.

Display shows rechargeable [NiMH] when the battery type is changed in setup option (Section 10).

Safety / EMC.

EMC In accordance with IEC61326 edition 2.

Locations: Class B locations.

Safety in accordance with BS EN 61010 -1 2010 + 61010 -30:2010

Installation Category: 600 V CAT III / 300 V CAT IV. (Max Phase to Phase 550 V)

In addition switch probe and test leads are designed to meet IEC 1010-031:2008, Double insulated to Installation Category III, 300 V phase to earth, 500 V phase to phase.

Repair and Warranty

The instrument contains static sensitive devices, and care must be taken in handling the printed circuit board. If an instrument's protection has been impaired it should not be used, but sent for repair by suitably trained and qualified personnel. The protection is likely to be impaired if for example, it shows visible damage, fails to perform the intended measurements, has been subjected to prolonged storage under unfavourable conditions, or has been subjected to severe transport stresses.

NEW INSTRUMENTS ARE GUARANTEED FOR 1 YEAR FROM THE DATE OF PURCHASE BY THE USER.

Note: Any unauthorised prior repair or adjustment will automatically invalidate the Warranty.

CALIBRATION, REPAIR AND SPARE PARTS

For service requirements for Megger Instruments contact:

Megger Limited
Archcliffe Road
Dover
Kent CT17 9EN
England.
Tel: +44 (0) 1304 502 243
Fax: +44 (0) 1304 207 342

Megger operate fully traceable calibration and repair facilities, ensuring your instrument continues to provide the high standard of performance and workmanship you expect. These facilities are complemented by a worldwide network of approved repair and calibration companies to offer excellent in-service care for your Megger products.

Returning your product to Megger - UK and USA service centres

1. When an instrument requires recalibration, or in the event of a repair being necessary, a Returns Authorisation (RA) number must first be obtained from one of the addresses shown above. You will be asked to provide the following information to enable the Service Department to prepare in advance for receipt of your instrument, and to provide the best possible service to you.
 - Model, e.g. MFT1731
 - Serial number, to be found on the underside of the case or on the calibration certificate.
 - Reason for return, e.g. calibration required, or repair.
 - Details of the fault if the instrument is to be repaired.
2. Make a note of the RA number. A returns label can be emailed or faxed to you if you wish.
3. Pack the instrument carefully to prevent damage in transit.
4. Ensure the returns label is attached, or that the RA number is clearly marked on the outside of the package and on any correspondence, before sending the instrument, freight paid, to Megger. Copies of the original purchase invoice and packing note should be sent simultaneously by airmail to expedite clearance through customs. In the case of instruments requiring repair outside the warranty period, an immediate quotation can be provided when obtaining the RA number.
5. You may track the progress of your return on line at www.megger.com

Approved Service Centres

A list of Approved Service Centres may be obtained from the UK address above, or from Megger's website at www.megger.com

Deceleration of Conformity

Hereby, Megger Instruments Limited declares that radio equipment manufactured by Megger Instruments Limited described in this user guide is in compliance with Directive 2014/53/EU. Other equipment manufactured by Megger Instruments Limited described in this user guide is in compliance with Directives 2014/30/EU and 2014/35/EU where they apply.

The full text of Megger Instruments EU declarations of conformity are available at the following internet address: megger.com/eu-dofc.

Megger Limited
Archcliffe Road
Dover Kent, CT17 9EN
England
Tel: +44 (0) 1304 502100
Fax: +44 (0) 1304 207342

Megger
4271 Bronze Way
Dallas
TX 75237-1017 U.S.A.
Tel: +1 (800) 723-2861 (U.S.A. only)
Tel: +1 (214) 330-3203 (International)
Fax: +1 (214) 337-3038

Megger
Valley Forge Corporate Centre
2621 Van Buren Avenue
Norristown, PA 19403, USA
Tel: +1 (610) 676-8500
Fax: +1 (610) 676-8610

Megger SARL
Z.A. Du Buisson de la Couldre
23 rue Eugène Henaff
78190 TRAPPES
France
Tel : +33 (1) 30.16.08.90
Fax : +33 (1) 34.61.23.77

Megger GmbH
Obere Zeil 2
61440 Oberursel
Germany
T 06171-92987-0
F 06171-92987-19

Megger Pty Limited
Unit 26 9 Hudson Avenue
Castle Hill
Sydney NSW 2125 Australia
T +61 (0)2 9659 2005
F +61 (0)2 9659 2201
E ausales@megger.com

**This instrument is manufactured in the United Kingdom.
The company reserves the right to change the specification or design without prior notice.**

Megger is a registered trademark.

The Bluetooth[®] word mark and logos are registered trademarks owned by Bluetooth SIG, Inc and is used under licence.

**MFT1711--MFT1721--MFT1731_UG_en_V04
www.megger.com**